

# CHOOSING A FLUE

## The Installer's Guide

 **RITE-VENT**  
*SCHIEDEL*

**schiedelrite-vent.co.uk**

### **Schiedel Rite-Vent**

Crowther Estate  
Washington  
Tyne & Wear NE38 0AQ  
Tel. +44 (0)191 416 1150  
Fax. +44 (0)191 415 1263  
sales@schiedelrite-vent.co.uk  
**www.schiedelrite-vent.co.uk**

### **Schiedel Chimney Systems**

Carrickmacross  
Co. Monaghan  
Ireland  
Tel. +353 (0)42 966 1256  
Fax. +353 (0)42 966 2494  
offices@schiedel.ie  
**www.schiedel.ie**

A company of  **LAFARGE**  
ROOFING

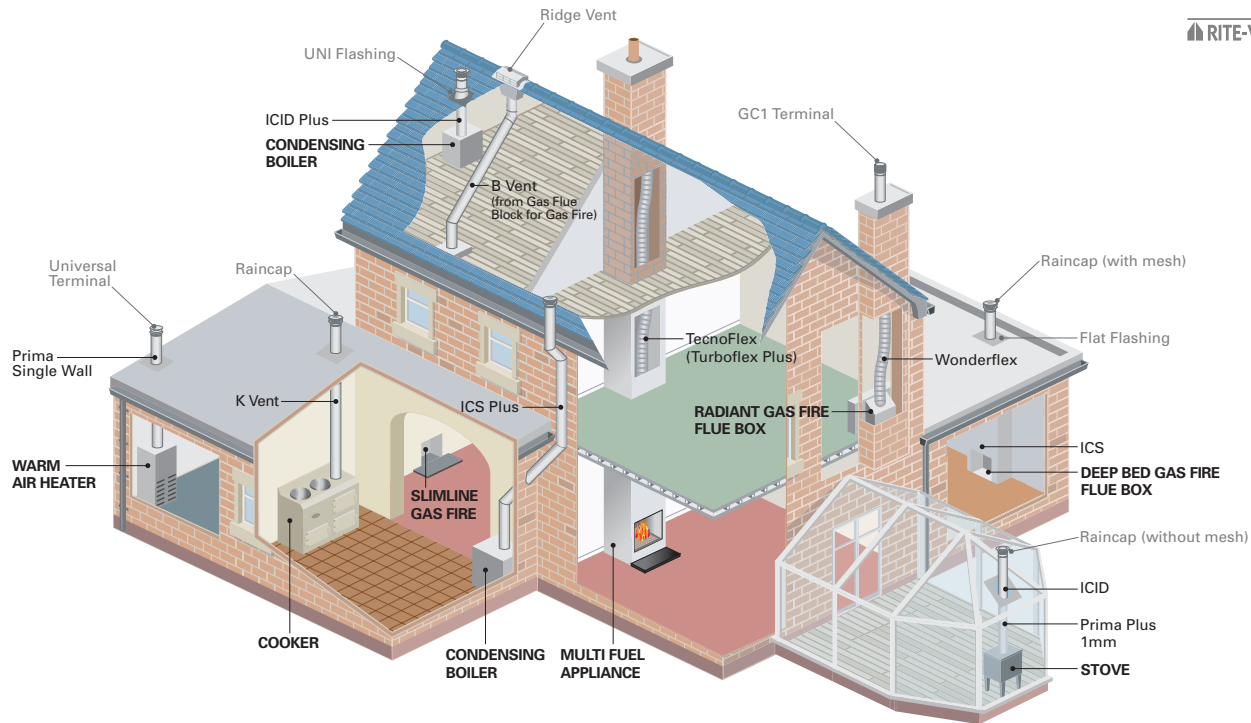

## Choose the right flue for your appliance

- Twin wall, single wall and flexible liners
- Suits both new and renovation projects

### Contents

<b>CE Designations</b>	_____	page 4
<b>ICS</b>	_____	page 6
<b>ICID</b>	_____	page 10
<b>B Vent</b>	_____	page 14
<b>K Vent</b>	_____	page 16
<b>Prima Plus</b>	_____	page 18
<b>Flue Boxes</b>	_____	page 22
<b>Flexible Liners</b>	_____	page 24

# CE Designations

## ...and how to make sense of them

The CE Designation Marking System is laid out as follows:

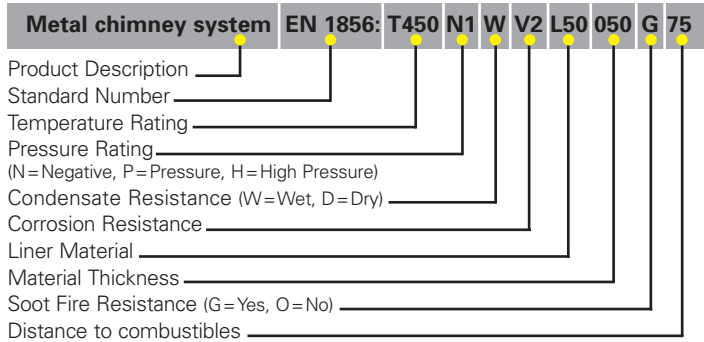

## Temperature Rating

Maximum temperature (°C) for continuous use of the flue. T450 is suitable for multifuel. T200 is suitable for gas and oil.

## Pressure Rating

Expressed as N for negative pressure applications, P for positive pressure and H for high positive pressure. Maximum allowed leakage rates are as defined below.

	Leakage rate (1/sec/m <sup>2</sup> )	Test pressure (Pa)
<b>N1</b>	2.0	40
<b>P1</b>	0.006	200
<b>P2</b>	0.12	200
<b>H1</b>	0.006	5000
<b>H2</b>	0.12	5000

For most applications, **N1** is suitable for conventional negative pressure boiler installations. **P1** is required for most positive pressure and fan flued boilers. **H** is for high pressure applications e.g. diesel generators, when the leakage rate is normally subject to specifier requirement.

## Condensate Resistance

Suitability for wet or dry operation. **W** designates ability to contain condensate within the flue, i.e. operating in the wet and dry conditions created by condensing appliances. **D** designates ability to operate under dry conditions only, usually meaning a flue gas temperature high enough to avoid condensate formation.

## Corrosion Resistance This is fuel dependent as follows:

- V1** Tested and approved as resistant to attack from products of combustion from gas.
- V2** Tested and approved as resistant to attack from products of combustion from light oil (sulphur content up to 0.2%) and natural wood.
- V3** Tested and approved as resistant to attack from products of combustion from heavy oil (sulphur content >0.2%), solid fuels and peat.
- Vm** Not tested and approved but rating declared by the manufacturer.

## Liner Material Specification

Two features are specified, firstly a code for the minimum material grade and secondly material thickness:

<b>L11</b>	<b>Aluminium 99% pure</b>
<b>L20</b>	<b>304</b>
<b>L30</b>	<b>304L</b>
<b>L40</b>	<b>316</b>
<b>L50</b>	<b>316L</b>
Thickness e.g. 060 means 0.6mm	

Normally liners expected to withstand the corrosion effect of multifuel, wood or heavy oil are made with 316L. Light oil is less corrosive and normally 304 has proved adequate in dry conditions, but in the increasingly common wet conditions created by high efficiency boilers, a higher grade is required (316L).

## Soot Fire Resistance

Expressed as either G, with soot fire resistance or O, without, followed by the declared minimum distance to combustibles expressed in mm. To obtain the G classification, means that the product has been tested at 1000°C for 30 minutes and remains intact and the temperature of combustible material at the designated distance does not exceed 100°C at T. amb. 20°C. Products with O classification mean the product is not rated as soot fire resistant. Normally this will occur with low temperature applications such as condensing gas boilers, where lip seals are used, which would not withstand a soot fire.

## Distance to Combustibles

Defined in soot fire resistance above. This definition is easily misunderstood. It has to be read in conjunction with the soot fire resistance classification and is NOT a stand alone classification.

## Product Description

**ICS** is a twin wall insulated chimney system for use on stoves, open fires, residential and small commercial multi fuel appliances, with continuous operating temperatures up to 450°C and short firing up to 550°C.

**ICS Plus** ICS is converted into ICS Plus by adding a gasket to each component. This creates a twin wall insulated chimney system designed for the new generation of condensing gas and oil appliances, with continuous operating temperatures up to 200°C, short firing up to 250°C, and positive pressure up to 200Pa at the appliance outlet.

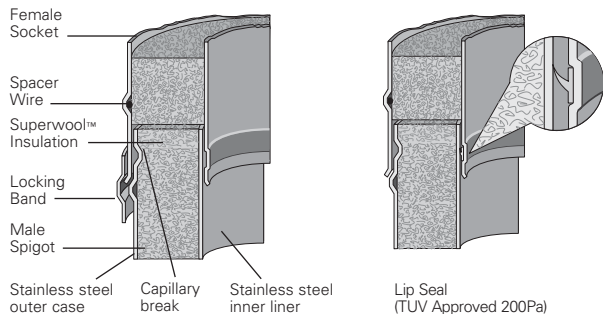

## Approvals

ICS is CE Certified to EN1856-1 TUV 0036 CPD 9195001 with designations T450 NI W V2 L50050 G75, T450 NI D V3 L50050 G75, T450 NI W V2 L50050 G50, T450 NI D V3 L50050 G50, T200 P1 W V2 L50050 025.

## Technical Data

	ICS	ICS Plus
Fuel	Gas, oil, wood, coal	Gas, oil
Firing Temp	450° C	200° C
Short Firing Temp	550° C	250° C
Thermal Shock	1000° C	-
Mode of Operation	Zero & negative pressure	Positive pressure
Pressure Capabilities	40Pa	200Pa
Fire Rating	4 Hour Fire Rating to BS 476 Part 20	
Outer Case	304 : 1.4301 : X5CrNi 18-10	
Outer Case Thickness	0.6mm	
Seam	Laser or inert gas welded	
Liner	316L : 1.4404 : X2CrNiMo 17-12-2	
Liner Thickness (mm)	0.5mm	
Seam	Laser or inert gas welded	
Insulation	High performance mineral fibre	
Insulation Thickness	25mm (50mm, 75mm, 100mm available)	
Average Thermal Resistance (200°C)	0.508m <sup>2</sup> kw	

## Load Bearing Data (metres of pipe)

Internal Diameter (mm)	80-130	150-180	200-300
Floor Support (Adj)	22	18	18
Wall Support	10	10	10
Wall Support (Inv)	15	15	15
90° Tee	22	18	18
135° Tee	15	10	10
Inspection Length	22	18	18
Support Plate	12	12	9

# ICS - Flue Selection Guide

	80 mm	100 mm	130 mm	150 mm	180 - 400mm
<b>Gas - Atmospheric Boiler</b>					
Input up to 25kw		•			
Input 25kw to 40kw			•		
Input 40kw to 60kw				•	
<b>Gas - Commercial/Ind. Boiler</b>					
Input 50kw to 70kw					• 2
<b>Gas Fires</b>					
'Radiant' to BS7977-1 2002			•		
'Inset' to BS7977-1 2002			• 1		• 1
'Backboiler' to BS7977-2 2003			•		
<b>Gas Water Heaters</b>					
Input up to 25kw	•	•			
Input 25kw to 55kw			•		
Input 55kw to 60kw				•	
Input over to 60kw					• 2
<b>Gas Warm Air Unit</b>					
Input up to 18kw		•			
Input 18kw to 35kw			•		
Input 35kw to 60kw				•	
Input over to 60kw					• 2
<b>Gas Stove/Cooker</b>		• 2	• 2	• 2	
<b>Kerosene (28sec Class C2)</b>					
Heating Boiler					
Output up to 25kw		•			
Output 25kw to 45kw			•		
Output 45kw to 70kw				•	
<b>Kerosene Stove/Cooker</b>		• 3	• 3	• 3	
<b>Kerosene Water Heater</b>					
Input up to 41kw				•	
<b>Kerosene Visual Effect Stove</b>					
Output up to 17kw		• 3	• 3		

	100 mm	130 mm	150 mm	180 mm	200 mm	230 mm	250 - 400mm
<b>Gas Boiler - Forced Draught</b>							
Input up to 25kw	•						
Input 25kw to 45kw		•					
Input 45kw to 50kw			•				
Input 50kw to 75kw				•			
Input 75kw to 100kw					•		
Input over to 100kw						•	• 2
<b>Gas Fires</b>							
'Inset' to BS7977-1 2002				• 1			
'Decorative' BSEN 509:2000				•			
<b>Gas Oil (35sec Class D)</b>							
Heating Boiler							
Output up to 25kw	•						
Output 25kw to 45kw		•					
Output 45kw to 70kw			•				
Output 70kw to 100kw				•			
Output over 100kw					• 3	• 3	• 3
<b>Solid Fuel</b>							
Heating Boiler							
Input up to 20kw			• S	• SC			
Input 20kw to 30kw				• S	• SC	• SC	
Input 30kw to 60kw					• SC	• SC	• SC
<b>Open Fires (standard opening)</b>							
500mm x 550mm					• 200min		
<b>Avant Garde Feature Open Fires</b>							• 4
<b>Room Heaters</b>			• S				
<b>Wood burning stoves and cookers</b>							
Use only seasoned wood.			•	• 200min			
<b>Inglenook/ non-standard opening</b>							
Flue size dependant on cross-sectional area of fireplace opening.						• 230min	

- Notes:**
- 1 Subject to appliance manufacturer's testing criteria.
  - 2 Subject to manufacturer's input rating and chimney height.
  - 3 Subject to manufacturer's output rating and chimney height.
  - 4 Min 300mm depending on opening chimney size and height.
- S** Smokeless fuel only.  
**SC** Smokeless fuel or coal.

## Product Description

**ICID** is a twin wall insulated chimney system specifically designed for use on stoves, class 1 chimneys, residential and small commercial and multi fuel appliances with continuous operating temperatures up to 450°C. The system is designed so that the laser welded 304BA stainless steel outer case is load bearing and the laser welded 316L stainless steel inner liner is free to expand independently to accommodate temperature change. It is soot fire resistant.

**ICID Plus** When fitted with a gasket on the liner spigot at every joint, ICID converts into a twin wall insulated chimney system designed for the new generation of condensing gas and oil appliances. Typically in this form the system can be operated at continuous operating temperatures up to 200°C, short firing up to 250°C and positive pressure up to 200Pa at the appliance outlet.

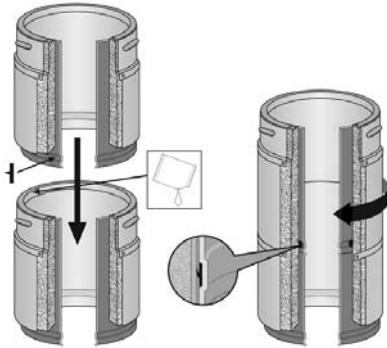

## Approvals

ICID is CE Certified to EN1856-1TUV 0036CPD9195010 with designations T450 NI W V2 L50050 G75, T450 NI D V3 L50050 G75, T450 NI W V2 L50050 G50, T450 NI D V3 L50050 G50, T200 PI W V2 L50050 025.

## Technical Data

	ICID	ICID Plus
Fuel	Gas, oil, wood, coal	Gas, oil
Firing Temp	450° C	200° C
Short Firing Temp	550° C	250° C
Thermal Shock	1000° C	-
Mode of Operation	Zero & negative pressure	Positive pressure
Pressure Capabilities	40Pa	200Pa
Outer Case	304 : 1.4301 : X5CrNi 18-10	
Outer Case Thickness	0.46mm	
Seam	Laser or inert gas welded	
Liner	316L : 1.4404 : X2CrNiMo 17-12-2	
Liner Thickness (mm)	0.5mm	
Seam	Laser or inert gas welded	
Insulation	High performance mineral fibre	
Insulation Thickness	25mm	
Average Thermal Resistance (200°C)	0.508m <sup>2</sup> kw	

## Load Bearing Data (metres of pipe)

Product	125	150	180	200- 300
Support Plate	9	9	9	6
Floor Support (Adj)	22	22	18	18
Wall Support (Inv)	15	15	15	15
Wall Support	10	10	10	10
Inspection Length	22	18	18	18
90° Tee	22	18	18	18
135° Tee	15	10	10	10

# ICID - Flue Selection Guide

	80 mm	100 mm	130 mm	150 mm	180 - 400mm
<b>Gas - Atmospheric Boiler</b>					
Input up to 25kw		•			
Input 25kw to 40kw			•		
Input 40kw to 60kw				•	
<b>Gas - Commercial/Ind. Boiler</b>					
Input 50kw to 70kw					• 2
<b>Gas Fires</b>					
'Radiant' to BS7977-1 2002			•		
'Inset' to BS7977-1 2002			• 1		• 1
'Backboiler' to BS7977-2 2003			•		
<b>Gas Water Heaters</b>					
Input up to 25kw	•	•			
Input 25kw to 55kw			•		
Input 55kw to 60kw				•	
Input over to 60kw					• 2
<b>Gas Warm Air Unit</b>					
Input up to 18kw		•			
Input 18kw to 35kw			•		
Input 35kw to 60kw				•	
Input over to 60kw					• 2
<b>Gas Stove/Cooker</b>		• 2	• 2	• 2	
<b>Kerosene (28sec Class C2)</b>					
Heating Boiler					
Output up to 25kw		•			
Output 25kw to 45kw			•		
Output 45kw to 70kw				•	
<b>Kerosene Stove/Cooker</b>		• 3	• 3	• 3	
<b>Kerosene Water Heater</b>					
Input up to 41kw				•	
<b>Kerosene Visual Effect Stove</b>					
Output up to 17kw		• 3	• 3		

	100 mm	130 mm	150 mm	180 mm	200 mm	230 mm	250 - 400mm
<b>Gas Boiler - Forced Draught</b>							
Input up to 25kw	•						
Input 25kw to 45kw		•					
Input 45kw to 50kw			•				
Input 50kw to 75kw				•			
Input 75kw to 100kw					•		
Input over to 100kw						•	• 2
<b>Gas Fires</b>							
'Inset' to BS7977-1 2002				• 1			
'Decorative' BSEN 509:2000				•			
<b>Gas Oil (35sec Class D)</b>							
Heating Boiler							
Output up to 25kw	•						
Output 25kw to 45kw		•					
Output 45kw to 70kw			•				
Output 70kw to 100kw				•			
Output over 100kw					• 3	• 3	• 3
<b>Solid Fuel</b>							
Heating Boiler							
Input up to 20kw			• S	• SC			
Input 20kw to 30kw				• S	• SC	• SC	
Input 30kw to 60kw					• SC	• SC	• SC
<b>Open Fires (standard opening)</b>							
500mm x 550mm					• 200min		
<b>Avant Garde Feature Open Fires</b>							• 4
<b>Room Heaters</b>			• S				
<b>Wood burning stoves and cookers</b>							
Use only seasoned wood.			•	• 200min			
<b>Inglenook/ non-standard opening</b>							
Flue size dependant on cross-sectional area of fireplace opening.						• 230min	

- Notes:**
- 1 Subject to appliance manufacturer's testing criteria.
  - 2 Subject to manufacturer's input rating and chimney height.
  - 3 Subject to manufacturer's output rating and chimney height.
  - 4 Min 300mm depending on opening chimney size and height.
- S** Smokeless fuel only.  
**SC** Smokeless fuel or coal.

# B Vent

## Product Description

**Twin wall gas heating system** designed for cost-effective venting of residential and small commercial atmospheric gas appliances with input up to 60kw. It is suitable for both internal and external use\*, either as a complete system or in combination with masonry, i.e. flue blocks or brick chimneys.

\*Note that BS 5440-1 requires the use of a stainless steel insulated flue on external runs exceeding 3 metres. K Vent fulfils this requirement and is fully interchangeable with the B Vent range.

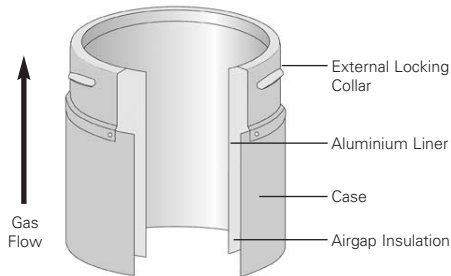

## Approvals **CE**

B Vent is CE certified to EN1856-1 with the designation T250 N1 D Vm L11040 050 (certificate number 0036 CPD9195013).

## Flue Selection Guide

B Vent is available in 75, 100, 125 and 150mm internal diameters. The flue size must be as recommended by the appliance manufacturer and **must not** be reduced, and never smaller than the appliance spigot.

This information is provided as a guide only, and for exact flue sizing recommendations, refer to appliance manufacturer's installation instructions and design guide.

	75mm	100mm	125mm	150mm
<b>Gas Central Heating Boiler</b> (wall hung/freestanding)				
Input up to 25kw		•		
Input 25kw to 40kw			•	
Input 40kw to 60kw				•
<b>Gas Fires</b>				
'Radiant' to BS 7977-1			•	
'Inset' to BS 7977-1			••	
'Backboiler' to BS 7977-2			•	
<b>Gas Water Heaters</b>				
Input up to 25kw	•	•		
Input 25kw to 55kw			•	
Input 55kw to 60kw				•
<b>Gas Stove/Cooker</b> (AGA/Rayburn/Stanley etc.)		•	•	•
<b>Gas Flue Blocks</b>				
Connection IN		•	•	
Connection OUT			•	
<b>Gas Warm Air Unit</b>				
Input up to 18kw		•		
Input 18kw to 35kw			•	
Input 35kw to 60kw				•

\*When the fire has been tested and relaxed to 125\* the appliance manufacturer should be consulted.



# K Vent

## Product Description

**Twin wall insulated venting system** specifically designed for residential and small commercial kerosene (28 second oil) and gas appliances. Especially useful on exposed external runs or cold roof spaces. BS5440-1-2000 5.1.7 requires the use of stainless steel insulated flue on all exterior gas flue runs exceeding 3 metres. K Vent fulfils this requirement and interconnects directly with the B Vent gas flue system for the most cost-effective solution.

K Vent is suitable for appliances that operate with a flue gas temperature that does not exceed 250°C. K Vent is only suitable for appliances that operate zero or negative pressure at the appliance outlet. For appliances that operate outside these conditions please refer to other products in the range or contact the installer helpline.

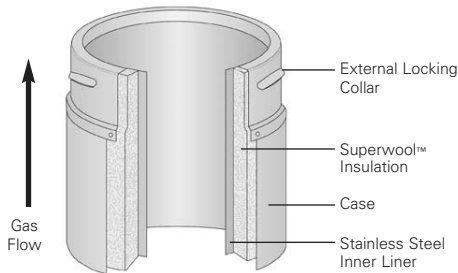

## Approvals **CE**

K Vent is CE certified to EN1856-1 with the designation T250 NI D Vm L20045 050 (certificate number 0036CPD9195014).

## Flue Selection Guide

K Vent is available in 100, 125 and 150mm internal diameters. The flue size must be as recommended by the appliance manufacturer and **must not** be reduced, and never smaller than the appliance spigot.

This information is provided as a guide only, and for exact flue sizing recommendations, refer to appliance manufacturer's installation instructions and design guide.

	100mm	125mm	150mm
<b>Kerosene Central Heating Boiler</b>			
Output up to 25kw	•		
Output 25kw to 45kw		•	
Output 45kw to 60kw			•
<b>Kerosene Stove/Cooker</b>	•	•	•
<b>Kerosene Water Heater</b>			
Input up to 41kw			•
<b>Kerosene Visual Effect Heater</b>			
Output up to 17kw	•	•	
<b>High Efficiency Gas Fires</b>			
'Radiant' to BS 7977-1 2002		•	
'Inset' to BS 7977-1 2002		••	
'Backboiler' to BS 7977-2 2003		•	
<b>Gas Flue Blocks</b>			
Connection OUT		•	

\*Subject to appliance manufacturer's testing criteria.

# Prima Plus

## Product Description

**Prima Plus** is a high quality 316L stainless steel single wall flue system with a wall thickness of 0.6mm. It is designed for use on gas and oil burning stoves and boilers with continuous operating temperatures up to 450°C and short firing up to 600°C. With the addition of a gasket to the joint, Prima Plus is designed for fluing condensing gas and oil appliances with positive pressures up to 200Pa, continuous operating temperatures up to 200°C and short firing up to 250°C. It can also be used for lining brick stacks for gas, oil, multi-fuel appliances and open fires as an alternative to flexible liner. (The exception is in England where Building Regulations now disallow the use of 0.6mm as a liner in domestic installations).

**Prima Plus 1mm** can be used for the same applications as Prima Plus. Additionally it is specifically designed for connecting solid fuel appliances to existing brick stacks or a twin wall chimney. It provides internal fluing of domestic woodburning, coal and multi-fuel stoves and boilers with normal operating temperatures up to 540°C and short firing up to 760°C.

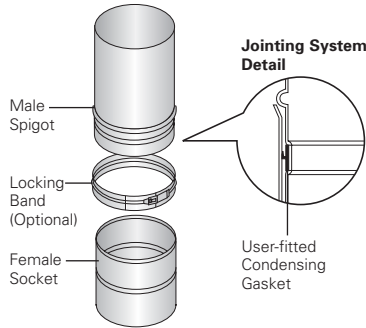

Prima Plus Connecting Flue Pipe is CE Certified to EN 1856-2 TUV 0036 CPD 9195 017 with designations T600 N1 W V2 L50060 G(400), T200 H1 W V2 L50060 O(200), T200 P1 W V2 L50060 O(200) and T200 N1 W V2 L50060 O(200).

## Approvals (contd.)

Single Wall System Chimney according to EN 1856-1 TUV 0036 CPD 9195 018, T600 N1 W V2 L50060 G(70).

Chimney Liner according to EN 1856-2 TUV 0036 CPD 9195 019, T600 N1 W V2 L50060 G and T200 P1 W V2 L50060 O.

The Prima range is manufactured under the strict requirements of BS EN ISO 9001:2000 Quality management scheme.

Prima Plus has corrosion certification from Gastec, MPA and TUV.

Prima Plus 1mm is listed by HETAS as a chimney suitable for solid fuel.

## Technical Data

	Prima Plus	Prima Plus (Condensing)
Fuel	Gas, oil, wood, coal	Gas, oil
Continuous Firing Temp	450° C	200° C
Short Firing Temp	600° C	-
Thermal Shock	1000° C	-
Mode of Operation	Zero & negative pressure	Zero, negative & positive pressure
Pressure Capabilities	100Pa	200Pa
Seam	Laser or inert gas welded	
Liner Thickness (mm)	P+ 0.6mm P+ 1 1.0mm	P+ 0.6mm P+ 1 1.0mm
Liner Material	316L : 1.4404 : X2CrNiMo 17-12-2	

## Load Bearing Data (metres of pipe)

Internal Diameter (mm)	80-130	150-180	200-300
Drain Support	20	20	15
Wall Support	20	20	15
Wall Support (Inv)	25	25	20
90° Tee	15	15	10
135° Tee	10	10	7

# Prima Plus - Flue Selection Guide

	80 mm	100 mm	130 mm	150 mm	180 - 400mm
<b>Gas - Atmospheric Boiler</b>					
Input up to 25kw		•			
Input 25kw to 40kw			•		
Input 40kw to 60kw				•	
<b>Gas - Commercial/Ind. Boiler</b>					
Input 50kw to 70kw					• 2
<b>Gas Fires</b>					
'Radiant' to BS7977-1 2002			•		
'Inset' to BS7977-1 2002			• 1		• 1
'Backboiler' to BS7977-2 2003			•		
<b>Gas Water Heaters</b>					
Input up to 25kw	•	•			
Input 25kw to 55kw			•		
Input 55kw to 60kw				•	
Input over to 60kw					• 2
<b>Gas Warm Air Unit</b>					
Input up to 18kw		•			
Input 18kw to 35kw			•		
Input 35kw to 60kw				•	
Input over to 60kw					• 2
<b>Gas Stove/Cooker</b>		• 2	• 2	• 2	
<b>Kerosene (28sec Class C2)</b>					
Heating Boiler					
Output up to 25kw		•			
Output 25kw to 45kw			•		
Output 45kw to 70kw				•	
<b>Kerosene Stove/Cooker</b>		• 3	• 3	• 3	
<b>Kerosene Water Heater</b>					
Input up to 41kw				•	
<b>Kerosene Visual Effect Stove</b>					
Output up to 17kw		• 3	• 3		

	100 mm	130 mm	150 mm	180 mm	200 mm	230 mm	250 - 400mm
<b>Gas Boiler - Forced Draught</b>							
Input up to 25kw	•						
Input 25kw to 45kw		•					
Input 45kw to 50kw			•				
Input 50kw to 75kw				•			
Input 75kw to 100kw					•		
Input over to 100kw						•	• 2
<b>Gas Fires</b>							
'Inset' to BS7977-1 2002				• 1			
'Decorative' BSEN 509:2000				•			
<b>Gas Oil (35sec Class D)</b>							
Heating Boiler							
Output up to 25kw	•						
Output 25kw to 45kw		•					
Output 45kw to 70kw			•				
Output 70kw to 100kw				•			
Output over 100kw					• 3	• 3	• 3
<b>Solid Fuel</b>							
Heating Boiler							
Input up to 20kw			• S	• SC			
Input 20kw to 30kw				• S	• SC	• SC	
Input 30kw to 60kw					• SC	• SC	• SC
<b>Open Fires (standard opening)</b>							
500mm x 550mm					• 200min		
<b>Avant Garde Feature Open Fires</b>							• 4
<b>Room Heaters</b>			• S				
<b>Wood burning stoves and cookers</b>							
Use only seasoned wood.			•	• 200min			
<b>Inglenook/ non-standard opening</b>							
Flue size dependant on cross-sectional area of fireplace opening.						• 230min	

- Notes:**
- 1 Subject to appliance manufacturer's testing criteria.
  - 2 Subject to manufacturer's input rating and chimney height.
  - 3 Subject to manufacturer's output rating and chimney height.
  - 4 Min 300mm depending on opening chimney size and height.
- S** Smokeless fuel only.  
**SC** Smokeless fuel or coal.

# Flue Boxes

## Standard Flue Box

Ref: 0182125

Designed for use with radiant and decorative gas fires complying to BS 7977-1 2002. Constructed with an aluminium liner and coated steel outer case.

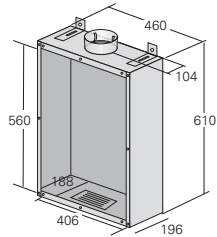

## Recessed Flue Box

Ref: 0183125

Designed with the spigot at the rear, for use with larger radiant and decorative gas fires. For gas fires to BS 7977-1 2002.

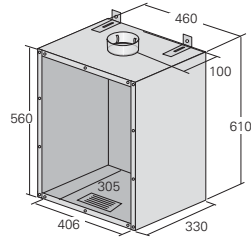

## ILFE Flue Box

Ref: 0188125 for use with Wonderflex & Triplelock

Ref: 4089180 for use with TecnoFlex (Turboflex Plus)

For use with Inset Live Fuel Effect gas fires complying to BS 7977-1 2002, with a heat output not exceeding 7kw.

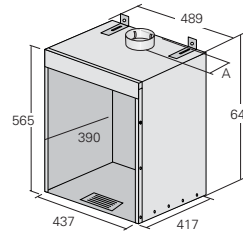

Wonderflex  
A = 122mm

TecnoFlex  
(Turboflex Plus)  
A = 149mm

## Large Flue for Back Boiler

Ref: 0165125

Adjustable in depth from 358mm to 480mm to accommodate a wide range of back boilers. Suitable for fires complying with BS 7977-2 2003. *Universal opening allowing connection to the boiler with B Vent or Flex.*

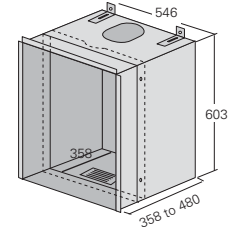

## GF Flue Box

Ref: 7T98125

Single wall design with sloping back to help fit some openings. For radiant gas fires complying with BS7977-1 2002.

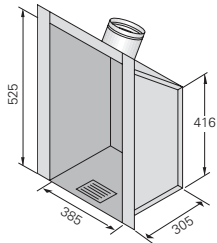

## DGF Flue Box

Ref: 4090180 for use with TecnoFlex (Turboflex Plus)

Manufactured with a ceramic inner wall, which simulates a fireplace opening, and a coated steel outer casing. Suitable for decorative gas fires with a heat input not exceeding 8kw. For appliances complying with BS EN 509: 2000.

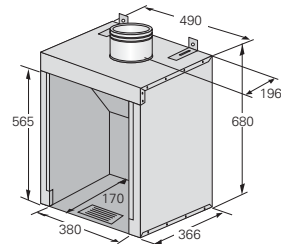

## VRV Single Skin Flue Box

Ref: 7T91125

Suitable for fires complying with BS7977-1 2002. Fits most popular radiant gas fires including the widely used Valor Firelite OxySAFE. Reduced height, extra depth and extra large flanges minimise builders work on installation.

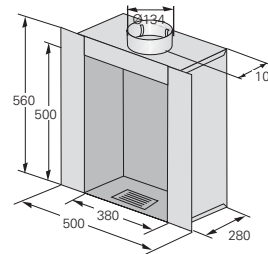

## VRV Twin Wall Flue Box

Ref: 7T95125

Twin wall construction for reduced condensation. Otherwise as VRV Single Skin Box.

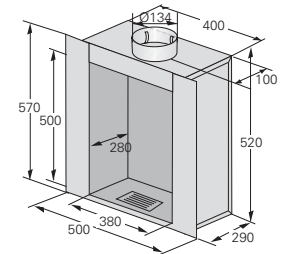

# Flexible Liners

## Product Description

Flexible flue and chimney liners designed for lining an existing flue or chimney.

**Wonderflex and Triplelock** are single wall stainless steel flexible flue liners designed for atmospheric gas and kerosene appliances where the flue gas temperature does not exceed 250°C. Diameter range Wonderflex 100 - 200mm, Triplelock 80 - 500mm.

**TecnoFlex (Turboflex Plus)** is a twin skin flexible chimney liner designed for gas, oil and multifuel, where the maximum flue gas temperature does not exceed 600°C. Diameter range 80 - 400mm.

### Wonderflex

overlap seam weld

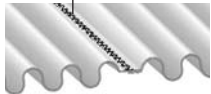

### Triplelock

dovetail folded triplelock seam

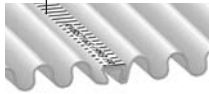

### TecnoFlex (Turboflex Plus)

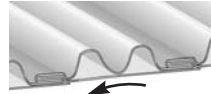

direction of flue gas flow

## Approvals

Wonderflex and Triplelock are both tested and Kitemarked to BS715:1993 in diameters 100, 125 and 150mm. TecnoFlex (Turboflex Plus), Wonderflex and Triplelock (Flexrite) are approved by HETAS and by CSTB (France) in diameters 125 to 200mm. All Rite-Vent flexible flue liners are manufactured under the stringent requirements of BS EN ISO 9001 - 2000 Quality management scheme. TecnoFlex (Turboflex Plus) is tested and approved by TÜV to EN 1856-1.

## Flexible Liners - Flue Selection Guide

Wonderflex and Triplelock	80 mm	100 mm	130 mm	150 mm	180 - 400mm
<b>Gas - Atmospheric Boiler</b>					
Input up to 25kw		•			
Input 25kw to 40kw			•		
Input 40kw to 60kw				•	
<b>Gas - Commercial/Ind. Boiler</b>					
Input 50kw to 70kw					• 2
<b>Gas Fires</b>					
'Radiant' to BS7977-1 2002			•		
'Inset' to BS7977-1 2002			• 1		• 1
'Backboiler' to BS7977-2 2003			•		
<b>Gas Water Heaters</b>					
Input up to 25kw	•	•			
Input 25kw to 55kw			•		
Input 55kw to 60kw				•	
Input over to 60kw					• 2
<b>Gas Warm Air Unit</b>					
Input up to 18kw		•			
Input 18kw to 35kw			•		
Input 35kw to 60kw				•	
Input over to 60kw					• 2
<b>Gas Stove/Cooker</b>		• 2	• 2	• 2	
<b>Kerosene (28sec Class C2)</b>					
Heating Boiler					
Output up to 25kw		•			
Output 25kw to 45kw			•		
Output 45kw to 70kw				•	
<b>Kerosene Stove/Cooker</b>		• 3	• 3	• 3	
<b>Kerosene Water Heater</b>					
Input up to 41kw				•	
<b>Kerosene Visual Effect Stove</b>					
Output up to 17kw		• 3	• 3		

- Notes:**
- 1 Subject to appliance manufacturer's testing criteria.
  - 2 Subject to manufacturer's input rating and chimney height.
  - 3 Subject to manufacturer's output rating and chimney height.
  - 4 Min 300mm depending on opening chimney size and height.
- S** Smokeless fuel only.  
**SC** Smokeless fuel or coal.

# Flexible Liners - Flue Selection Guide

<b>TecnoFlex (Turboflex Plus)</b>	100 mm	130 mm	150 mm	180 mm	200 mm	230 mm	250 - 400mm
<b>Gas Boiler - Forced Draught</b>							
Input up to 25kw	•						
Input 25kw to 45kw		•					
Input 45kw to 50kw			•				
Input 50kw to 75kw				•			
Input 75kw to 100kw					•		
Input over to 100kw						•	• 2
<b>Gas Fires</b>							
'Inset' to BS7977-1 2002				• 1			
'Decorative' BSEN 509:2000				•			
<b>Gas Oil (35sec Class D)</b>							
Heating Boiler							
Output up to 25kw	•						
Output 25kw to 45kw		•					
Output 45kw to 70kw			•				
Output 70kw to 100kw				•			
Output over 100kw					• 3	• 3	• 3
<b>Solid Fuel</b>							
Heating Boiler							
Input up to 20kw			• S	• SC			
Input 20kw to 30kw				• S	• SC	• SC	
Input 30kw to 60kw					• SC	• SC	• SC
<b>Open Fires (standard opening)</b>							
500mm x 550mm					• 200min		
<b>Avant Garde Feature Open Fires</b>							• 4
<b>Room Heaters</b>			• S				
<b>Wood burning stoves and cookers</b> Use only seasoned wood which has been stored 1/2 years in dry conditions.			•	• 180min			
<b>Inglenook/non-standard opening</b> The cross sectional area of the chimney liner must be a minimum of 15% of the total cross sectional area of the fireplace opening.						• 230min	

- Notes:**
- 1 Subject to appliance manufacturer's testing criteria.
  - 2 Subject to manufacturer's input rating and chimney height.
  - 3 Subject to manufacturer's output rating and chimney height.
  - 4 Min 300mm depending on opening chimney size and height.
- S** Smokeless fuel only.  
**SC** Smokeless fuel or coal.

## Flue Selection Guide

The chimney size should be as recommended by the appliance manufacturer. Where there is a requirement for a flue diameter smaller than the appliance spigot, then the operational requirements of the appliance and the configuration of the flue must satisfy the flue sizing requirements of DIN4705. For more information contact the installer helpline. The information and sizes overleaf are provided as a nominal guide only. For Inglenook and non-standard openings, the diameter of the flue must be at least 15% of the cross sectional area of the fireplace opening.

## Flue Support

Wall brackets and roof brackets are not load bearing and give lateral support only. Wall brackets should be fitted every 3m and at any offsets to ensure the system is rigidly supported.

## Keep up to Date

Sign up to our web site now for FREE regular updates on Schiedel Rite-Vent products and industry developments.

More information on  
**[www.schiedelrite-vent.co.uk](http://www.schiedelrite-vent.co.uk)**



**INSTALLER HELPLINE**  
**+44 (0) 191 416 6666**