

Pellet

Sigma – Single Wall Matt Black	2.2
Nova – Twin Wall Chimney System	2.4
Nova Matt Black – Twin Wall Chimney System	2.10
Flexible Flue Liner & Fittings	2.14

Sigma

Suitable for: Woodburning & Solid Fuel

Designation Number: T600 N1 D V2 L50060 G

Condensing	Locking Bands Req.	Locking Bands Inc.	Distance to Combustibles	Material	Insulation Thickness	Manufacturer	Manufactured in the UK	Warranty
X	X	X	3 x Diameter if painted 400mm if unpainted	0.6mm 316L Stainless Steel	N/A	SFL	✓	10 years

Product Description	Diameter	Part No.	Price
---------------------	----------	----------	-------

Adaptor for Top Outlets



Black MCZ Cute / Thema Starter Length 875mm (incl. Sweep Access and Test Point)
Starter length designed to fit specifically onto the MCZ Cute & Thema top outlet, with sweep access & test point

100mm 3304101 **£91.90**

Adaptor for Rear Outlets



Black MCZ Stove Appliance Connector 650mm (incl. Spigot, Sweep Access and Test Point)
Starter length designed to fit specifically onto the MCZ rear outlet, with sweep access & test point

100mm 3304094 **£184.11**

Did you know?

Our Sigma starter adaptor was specially designed to fit with MCZ appliances

#designedtobebetter

Product Description	Diameter	Part No.	Price
---------------------	----------	----------	-------

Components

	Black 1010mm Straight Length Standard straight length of flue	100mm	3304002	£73.49
	Black 480mm Straight Length Standard straight length of flue	100mm	3304005	£46.78
	Black Adjustable Length (1 Piece) 50 - 480mm One piece pipe used to adjust the length of existing pipe 50 - 480mm inc clamp band	100mm	3304015	£59.27
	Black 45° Bend Used for changing flue direction	100mm	3304022	£51.79
	Black Wall Guide 50 - 400mm Wall bracket for lateral support, can be cut to suit between 50 - 400mm distance from the wall	100mm	3304088	£118.01
	Black Concentric Increaser Used to increase the appliance outlet spigot to a larger diameter	100 - 130mm	3304097	£116.03
		100 - 150mm	3304096	£122.00
	Stainless Steel Flex Adaptor Used to connect Sigma single wall to flexible flue liner	130mm	3305090	£39.18
		150mm	3306090	£42.19



Do you need?

Draught Stabilisers

We stock Haas and Sohn, find them on page 7.10



Top & Rear Outlet

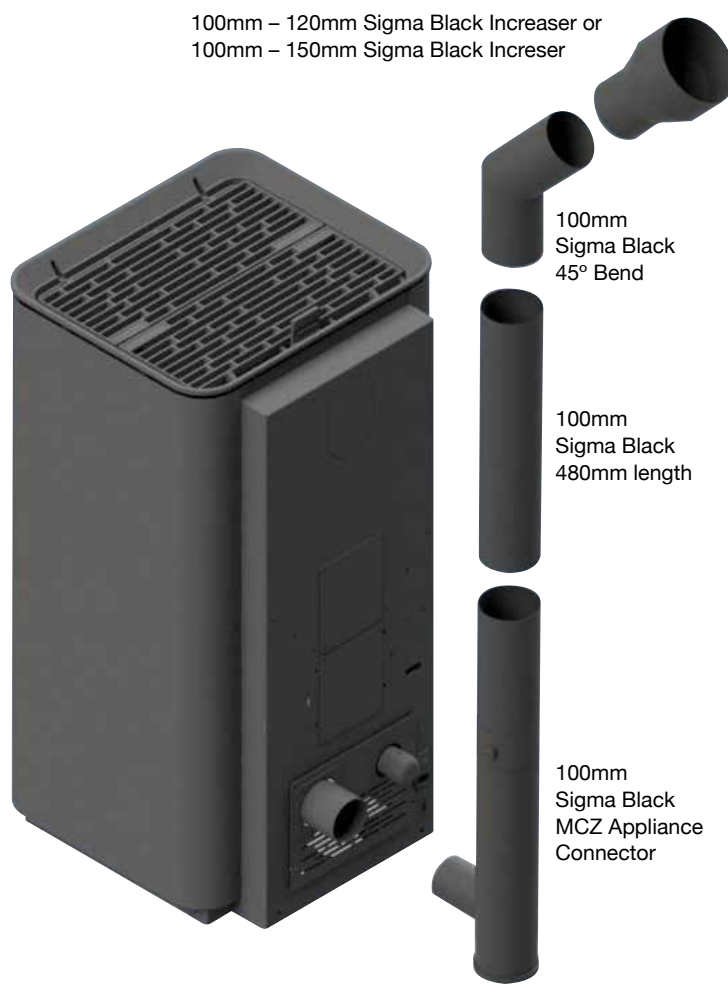
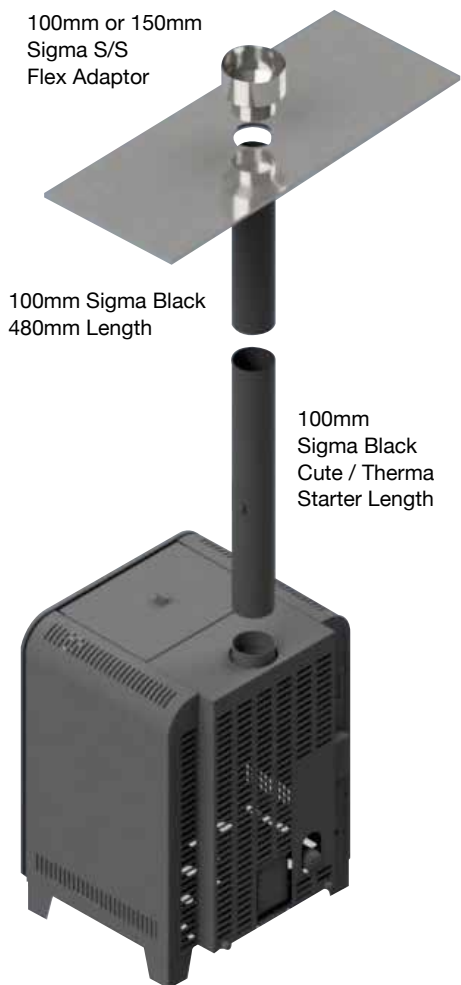





Nova









Suitable for: Woodburning, Solid Fuel, Gas & Oil









Designation Number: T450 N1 D V2 L50050 GSO (without seals) , T200 P1 W V2 L50050 050 (with seals)









Condensing	Locking Bands Req.	Locking Bands Inc.	Distance to Combustibles	Material	Insulation Thickness	Manufacturer	Manufactured in the UK	Warranty
✓ (add seals)	✓	✓	50mm	316 / 304 Stainless Steel	25mm	SFL	✓	20 years







Product Description	Diameter	Part No.	Price
Starting Components			
 Appliance Adaptor Used to connect from an appliance or connecting flue pipe to Nova chimney system	100mm	1104094	£38.25
	130mm	1105094	£42.21
	150mm	1106094	£44.69
	180mm	1107094	£49.91
	200mm	1108094	£53.99
 Appliance Adaptor (Imperial) Used for connecting imperial sized spigots on appliances or connecting flue pipe	130mm	1105095	£33.02
	180mm	1107095	£41.44
 Anchor / Mounting Plate Used to connect Nova to a lintel or pre-cast chamber Square plate with single wall spigot below	100mm	1104527	£79.06
	130mm	1105527	£86.37
	150mm	1106527	£106.43
	180mm	1107527	£113.97
 Supra – Nova Adaptor Supra connecting flue pipe to Nova chimney system	100mm	1104096	£46.55
	130mm	1105096	£50.64
	150mm	1106096	£55.43
	180mm	1107096	£63.48
 Supra – Nova Increasing Adaptor Supra connecting flue pipe to larger diameter Nova chimney system	100 – 130mm	1105098	£46.48
	130 – 150mm	1106098	£85.81
 SM250 / SMW – Nova Adaptor SFL S Flue to Nova chimney system adaptor	130mm	1105990	£86.61
	150mm	1106990	£93.52
	180mm	1107990	£101.39
	200mm	1108990	£108.62
 Starter Length Stainless Steel 996mm Installed length tapered Starter Length Can connect from the appliance outlet or connecting flue pipe	130mm	1105101	£173.57
	150mm	1106101	£188.63
	180mm	1107101	£213.58
	200mm	1108101	£216.21
 Starter Length White 996mm Installed length tapered Starter Length Can connect from the appliance outlet or connecting flue pipe	130mm	1105102	£177.56
	150mm	1106102	£192.65
	180mm	1107102	£217.61
	200mm	1108102	£220.23

Product Description	Diameter	Part No.	Price
Pipes			
 1000mm Straight Length Standard straight length of flue	100mm	1104002	£147.59
	130mm	1105002	£168.87
	150mm	1106002	£185.08
	180mm	1107002	£208.46
	200mm	1108002	£230.55
 500mm Straight Length Standard straight length of flue	100mm	1104005	£113.23
	130mm	1105005	£126.60
	150mm	1106005	£133.11
	180mm	1107005	£152.96
 250mm Straight Length Standard straight length of flue	100mm	1104012	£82.81
	130mm	1105012	£91.70
	150mm	1106012	£93.00
	180mm	1107012	£108.16
 120mm Straight Length Standard straight length of flue	100mm	1104006	£68.77
	130mm	1105006	£73.33
	150mm	1106006	£77.71
	180mm	1107006	£83.11
 Adjustable Length – Long Two piece adjustable length 310 – 500mm adjustment Two seals required for positive pressure or wet systems	100mm	1104015	£142.26
	130mm	1105015	£147.58
	150mm	1106015	£155.05
	180mm	1107015	£167.09
 Adjustable Length – Short Two piece adjustable length 210 – 320mm adjustment Two seals required for positive pressure or wet systems	100mm	1104018	£138.82
	130mm	1105018	£145.28
	150mm	1106018	£147.87
	180mm	1107018	£160.66
 Inspection Length – Standard (N1/D) 500mm installed length with access door for flue inspection for negative pressure / dry systems only	130mm	1105013	£564.97
	150mm	1106013	£586.67
	180mm	1107013	£597.42
	200mm	1108013	£622.36

Product Description	Diameter	Part No.	Price
 Duct Drain Length Used in an incline position to trap condensate and allow drainage Fitted with a standard s/s BSP thread connection and incorporates an internal back flow dam	100mm	1104009	£176.94
	130mm	1105009	£197.04
	150mm	1106009	£196.46
	180mm	1107009	£219.15
	200mm	1108009	£230.85
 Probe Length Used to allow flue gas analysis the length is supplied with a M16 threaded washer and bolt Cover jacket supplied to cover sampling point when not in use	100mm	1104534	£146.32
	130mm	1105534	£150.70
	150mm	1106534	£160.27
	180mm	1107534	£186.64
	200mm	1108534	£189.87
Elbows / Tees			
 90° Equal Tee Designed to connect from connecting flue pipe to a chimney system or the branch may be used to locate a draft stabiliser	100mm	1104043	£212.98
	130mm	1105043	£214.43
	150mm	1106043	£231.84
	180mm	1107043	£262.08
	200mm	1108043	£285.75
 H&S Stabiliser Adaptor Adaptor from Nova tee branch to H & S Energy Draught Regulator	100 – 130mm	1104099	£90.38
	130mm	1105099	£62.64
	150mm	1106099	£78.97
	180 – 150mm	1107099	£97.52
	200mm	1108099	£97.00
 95° Tee Designed to connect from connecting flue pipe to a chimney system or for horizontal header configurations	100mm	1104042	£222.22
	130mm	1105042	£229.61
	150mm	1106042	£250.42
	180mm	1107042	£280.74
	200mm	1108042	£309.15
 135° Tee Designed to be used in combination with a 45° bend from connecting flue pipe to a chimney system	100mm	1104044	£285.77
	130mm	1105044	£357.29
	150mm	1106044	£320.32
	180mm	1107044	£443.05
	200mm	1108044	£476.22
 Locking Plug Used to close off the base or branch of a tee piece for inspection access	100mm	1104091	£91.39
	130mm	1105091	£93.69
	150mm	1106091	£98.23
	180mm	1107091	£103.42
	200mm	1108091	£113.08
 Condensate Collector (Drain Tee Cap) Used at the base of a vertical chimney to allow drainage of condensate from the system Fitted with a BSP drain connection	100mm	1104532	£101.64
	130mm	1105532	£105.87
	150mm	1106532	£110.53
	180mm	1107532	£115.60
	200mm	1108532	£120.73

Product Description	Diameter	Part No.	Price
 15° Bend Used for changing flue direction	100mm	1104025	£125.02
	130mm	1105025	£128.38
	150mm	1106025	£137.57
	180mm	1107025	£145.25
	200mm	1108025	£159.75
 30° Bend Used for changing flue direction	100mm	1104024	£125.02
	130mm	1105024	£128.38
	150mm	1106024	£137.57
	180mm	1107024	£145.25
	200mm	1108024	£159.75
 45° Bend Used for changing flue direction	100mm	1104022	£125.02
	130mm	1105022	£128.38
	150mm	1106022	£137.57
	180mm	1107022	£145.25
	200mm	1108022	£159.75
 85° Bend Used for changing flue direction	100mm	1104020	£212.09
	130mm	1105020	£216.51
	150mm	1106020	£224.58
	180mm	1107020	£239.47
	200mm	1108020	£263.55
 90° Bend Used for changing flue direction	100mm	1104021	£210.41
	130mm	1105021	£213.55
	150mm	1106021	£222.34
	180mm	1107021	£240.55
	200mm	1108021	£254.89
 90° Inspection Elbow Used for changing flue direction with inspection access door	130mm	1105019	£348.22
	150mm	1106019	£360.30
	180mm	1107019	£375.85
	200mm	1108019	£387.89
	Support / Penetration Components		
 Support Length 117mm Installed length with an incorporated plate with slotted holes for rotational adjustment	100mm	1104004	£125.57
	130mm	1105004	£131.70
	150mm	1106004	£156.10
	180mm	1107004	£157.66
	200mm	1108004	£177.46
 Roof / Rafter Support Flue band with adjustable and locking gimbal plates to support the chimney on roof joists or trussed rafters See Nova brochure for support info	100mm	1104029	£77.47
	130mm	1105029	£78.05
	150mm	1106029	£78.41
	180mm	1107029	£78.99
	200mm	1108029	£79.36
 Locking Band Used to fasten around all joints Included with each component with a female coupler	100mm	1104086	£8.88
	130mm	1105086	£9.35
	150mm	1106086	£9.44
	180mm	1107086	£9.57
	200mm	1108086	£9.96

Product Description	Diameter	Part No.	Price
 Joint Sealing Ring Use on every joint for condensing applications	100mm	1104832	£1.87
	130mm	1105832	£2.18
	150mm	1106832	£2.56
	180mm	1107832	£2.71
	200mm	1108832	£2.91
 SFL Universal Lubricant Used in conjunction with joint sealing ring		1105833	£26.16
 Wall Support Bracket St/St (Support Length Included) Standard wall support offering 50mm from wall distance, includes support length, plate & triangular side plates	100mm	1104061	£183.31
	130mm	1105061	£196.58
	150mm	1106061	£226.48
	180mm	1107061	£244.50
	200mm	1108061	£266.23
 Wall Support Bracket Galv (Support Length Included) Standard wall support offering 50mm from wall distance, includes support length, plate & triangular side plates (internal use)	100mm	1104062	£134.38
	130mm	1105062	£142.81
	150mm	1106062	£161.03
	180mm	1107062	£166.28
	200mm	1108062	£180.79
 Wall Support Short – up to 145mm Wall Support offering extension from the wall Internal & external use	100mm	1104031	£145.65
	130mm	1105031	£150.36
	150mm	1106031	£154.20
	180mm	1107031	£160.75
	200mm	1108031	£165.67
 Wall Support Long – up to 350mm Wall Support offering extension from the wall Internal & external use	100mm	1104032	£151.54
	130mm	1105032	£156.24
	150mm	1106032	£160.07
	180mm	1107032	£166.62
	200mm	1108032	£171.54
 Galvanised Wall Band Galvanised Wall Band to provide lateral support at a 50mm distance from the wall, for internal use.	100mm	1104088	£25.30
	130mm	1105088	£22.59
	150mm	1106088	£26.07
	180mm	1107088	£26.43
	200mm	1108088	£26.80
 Stainless Steel Wall Band Stainless Steel Wall Band to provide lateral support at a 50mm distance from the wall, for internal & external use.	100mm	1104067	£29.42
	130mm	1105067	£27.22
	150mm	1106067	£31.71
	180mm	1107067	£32.66
	200mm	1108067	£33.46
 Wall Band With Short Extension – 55 – 295mm Lateral support Wall Band offering adjustable extension from the wall	100mm	1104065	£60.12
	130mm	1105065	£62.67
	150mm	1106065	£64.90
	180mm	1107065	£67.82
	200mm	1108065	£70.16

Product Description	Diameter	Part No.	Price
 Wall Band With Long Extension – 55 – 500mm Lateral support Wall Band offering adjustable extension from the wall	100mm	1104069	£65.59
	130mm	1105069	£68.03
	150mm	1106069	£70.26
	180mm	1107069	£73.17
	200mm	1108069	£75.52
 Ceiling Support (T250) Provides support and a 50mm air gap clearance to a penetrated floor or ceiling and is only used where the chimney passes through non-combustible floors and / or services a gas or oil fired appliance where the flue gas does not exceed 250°C	100mm	1104027	£35.38
	130mm	1105027	£37.64
	150mm	1106027	£41.87
	180mm	1107027	£43.95
	200mm	1108027	£66.23
 Firestop Spacer (T250) Used where chimney passes through non-combustible floors and / or serves a gas or oil fired appliance where the flue gas does not exceed 250°C – not load bearing	100mm	1104087	£5.54
	130mm	1105087	£6.44
	150mm	1106087	£7.18
	180mm	1107087	£8.10
	200mm	1108087	£9.61
 D5 White Ventilated Ceiling Support Used to both support & firestop the chimney system Offers an aesthetically pleasing flat appearance Fire Rated Acrylic Sealant to be used	100mm	1104108	£125.45
	130mm	1105108	£135.56
	150mm	1106108	£142.89
	180mm	1107108	£157.53
	200mm	1108108	£159.41
 Ventilated Ceiling Support (T450) St/St Vented Ceiling Support used to both support & firestop the chimney system Fire Rated Acrylic Sealant to be used	100mm	1104107	£98.48
	130mm	1105107	£109.80
	150mm	1106107	£115.74
	180mm	1107107	£127.60
	200mm	1108107	£129.10
 Ventilated Ceiling Support (T450) White Vented Ceiling Support used to both support & firestop the chimney system Fire Rated Acrylic Sealant to be used	100mm	1104105	£98.48
	130mm	1105105	£109.80
	150mm	1106105	£115.74
	180mm	1107105	£127.60
	200mm	1108105	£129.12
 Ventilated Firestop (T450) Used where chimney passes through combustible floors and where sections are enclosed in a non combustible shaft – not load bearing	100mm	1104082	£65.22
	130mm	1105082	£72.28
	150mm	1106082	£79.32
	180mm	1107082	£90.75
	200mm	1108082	£105.76







Do you need?

Guy Wire, Grips and Strainers or Rigid Roof Stays



See the Fixings section on page 7.10

Product Description	Diameter	Part No.	Price
 Flue Enclosure Kit 2400mm 2 x 1200mm long mesh enclosures with bands and fittings, designed to be used within a loft space to ensure distance & ventilation around chimney system	130mm	1105557	£215.72
	150mm	1106557	£215.72
	180mm	1107557	£215.72
	200mm	1108557	£215.72
 Guy Wire Bracket Used to secure unsupported chimney sections above the roof level in conjunction with wires or rigid stays	130mm	1105092	£18.95
	150mm	1106092	£20.46
	180mm	1107092	£22.63
	200mm	1108092	£37.00
 Fire Rated Acrylic Sealant Must be used for Ventilated Firestop / Ceiling Supports A substantial bead to be applied to the upper surface of the lower firestop plate in the groove before the foil matrix	—	1105083	£14.06
 Standard Horizontal Wall Trim Collar (St/St) Polished stainless steel one piece trim collar Offering a nominal 105mm wide circular flange used to neaten where the chimney system passes through the wall	100mm	1104085	£24.24
	130mm	1105085	£25.79
	150mm	1106085	£27.55
	180mm	1107085	£29.50
	200mm	1108085	£31.48
 0 – 10° Angled Wall Cover Ring Two piece elliptical collar allowing multiple angles between 0-10° for when chimney system passes through a roof eg vaulted ceilings, single storey extensions	130mm	1105110	£30.17
	150mm	1106110	£34.27
	180mm	1107110	£35.53
	200mm	1108110	£38.22

Product Description	Diameter	Part No.	Price
 10 – 20° Angled Wall Cover Ring Two piece elliptical collar allowing multiple angles between 10–20° for when chimney system passes through a roof eg vaulted ceilings, single storey extensions	130mm	1105120	£30.17
	150mm	1106120	£34.27
	180mm	1107120	£35.53
	200mm	1108120	£38.22
 30 – 40° Angled Wall Cover Ring Two piece elliptical collar allowing multiple angles between 30–40° for when chimney system passes through a roof eg vaulted ceilings, single storey extensions	130mm	1105140	£30.17
	150mm	1106140	£34.27
	180mm	1107140	£35.53
	200mm	1108140	£38.22
 40 – 50° Angled Wall Cover Ring Two piece elliptical collar allowing multiple angles between 40 – 50° for when chimney systems passes through a roof eg vaulted ceilings, single storey extensions	130mm	1105150	£30.17
	150mm	1106150	£34.27
	180mm	1107150	£35.53
	200mm	1108150	£38.22
 135° Wall Sleeve (Combustible Wall) Mitred sleeve used to protect the building where the flue passes through	100mm	1104050	£88.92
	130mm	1105050	£41.62
	150mm	1106050	£78.41
	180mm	1107050	£78.41
 135° Wall Sleeve (Non Combustible Wall) Mitred sleeve used to protect the building where the flue passes through	100mm	1104051	£88.92
	130mm	1105051	£41.62
	150mm	1106051	£78.41
	180mm	1107051	£78.41
Terminals / Flashings			
 Adaptor to Flexible Top Adaptor from Nova Chimney System to Flexible Liner	100mm	1104063	£37.23
	130mm	1105063	£42.58
	150mm	1106063	£48.85
	180mm	1107063	£53.99
 Nova to SM250 / SMW adaptor / S Flue Nova Chimney System to S Flue adaptor	130mm	1105991	£86.61
	150mm	1106991	£93.52
	180mm	1107991	£101.39
	200mm	1108991	£108.62
 Nova to Supra Adaptor Top Adaptor from Nova Chimney System to Supra Chimney System	100mm	1104097	£49.50
	130mm	1105097	£55.94
	150mm	1106097	£60.10
	180mm	1107097	£68.05
	200mm	1108097	£72.75

Product Description	Diameter	Part No.	Price
Top Stub (No Mesh) Open Terminal which offers the least resistance to flue gases, suitable for solid fuel appliances where drainage provision at the base	100mm	1104073	£54.26
	130mm	1105073	£56.17
	150mm	1106073	£58.51
	180mm	1107073	£61.15
	200mm	1108073	£74.46
Top Stub (With Mesh) Open Terminal which offers the least resistance to flue gases, not suitable for high temperature appliances & needs drainage provision at the base	100mm	1104077	£107.28
	130mm	1105077	£113.60
	150mm	1106077	£129.55
	180mm	1107077	£133.76
	200mm	1108077	£138.92
Round Top Similar to the raincap style but offers more protection against driving rain & wind	100mm	1104075	£58.09
	130mm	1105075	£100.19
	150mm	1106075	£106.88
	180mm	1107075	£115.91
	200mm	1108075	£128.90
Rain Cap Designed to offer some protection from rain water	100mm	1104074	£46.28
	130mm	1105074	£47.95
	150mm	1106074	£50.01
	180mm	1107074	£55.74
	200mm	1108074	£93.48
Storm Cowl Designed to offer the maximum protection against wind & driving rain (Not an antidowndraught terminal)	100mm	1104076	£81.93
	130mm	1105076	£90.69
	150mm	1106076	£99.02
	180mm	1107076	£100.20
	200mm	1108076	£106.35
Flat Flashing Aluminium flat roof flashing	100mm	1104038	£41.80
	130mm	1105038	£39.93
	150mm	1106038	£42.19
	180mm	1107038	£47.46
	200mm	1108038	£50.42
Adjustable Flashing 5 – 30° Aluminium angled roof flashing	130mm	1105035	£39.93
	150mm	1106035	£42.19
	180mm	1107035	£47.38
	200mm	1108035	£50.42
Adjustable Flashing 32–45° Aluminium angled roof flashing	130mm	1105036	£47.46
	150mm	1106036	£50.42
	180mm	1107036	£65.25
	200mm	1108036	£68.22
Storm Collar (Supplied With Sealant) Used to weather the top of the flashing, supplied with a tube of silicone sealant	100mm	1104041	£19.29
	130mm	1105041	£20.04
	150mm	1106041	£21.40
	180mm	1107041	£24.48
	200mm	1108041	£25.96

Nova Mitred Bend Dimensions

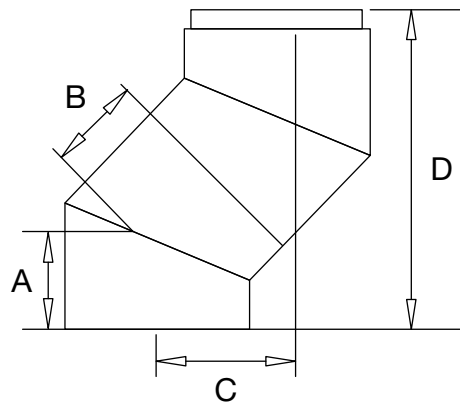

15° Elbow					
Diameter	100	130	150	180	200
A	91	98	102	108	112
B	100	111	111	123	128
C	47	51	53	56	58
D	358	385	401	425	440

30° Elbow					
Diameter	100	130	150	180	200
A	91	98	102	108	112
B	111	122	122	139	145
C	91	98	102	108	112
D	340	366	381	403	418

45° Elbow					
Diameter	100	130	150	180	200
A	91	98	102	108	112
B	118	131	131	149	157
C	129	139	144	153	158
D	311	335	348	369	382

Can't find what you're looking for?

Send us a drawing and we can get a quote to get it especially made for you.

#designedtobebetter

Do you need?

Exodraft Fans and Accessories

See page 7.2–7.4

Typical Domestic Installation

Internal System Chimney

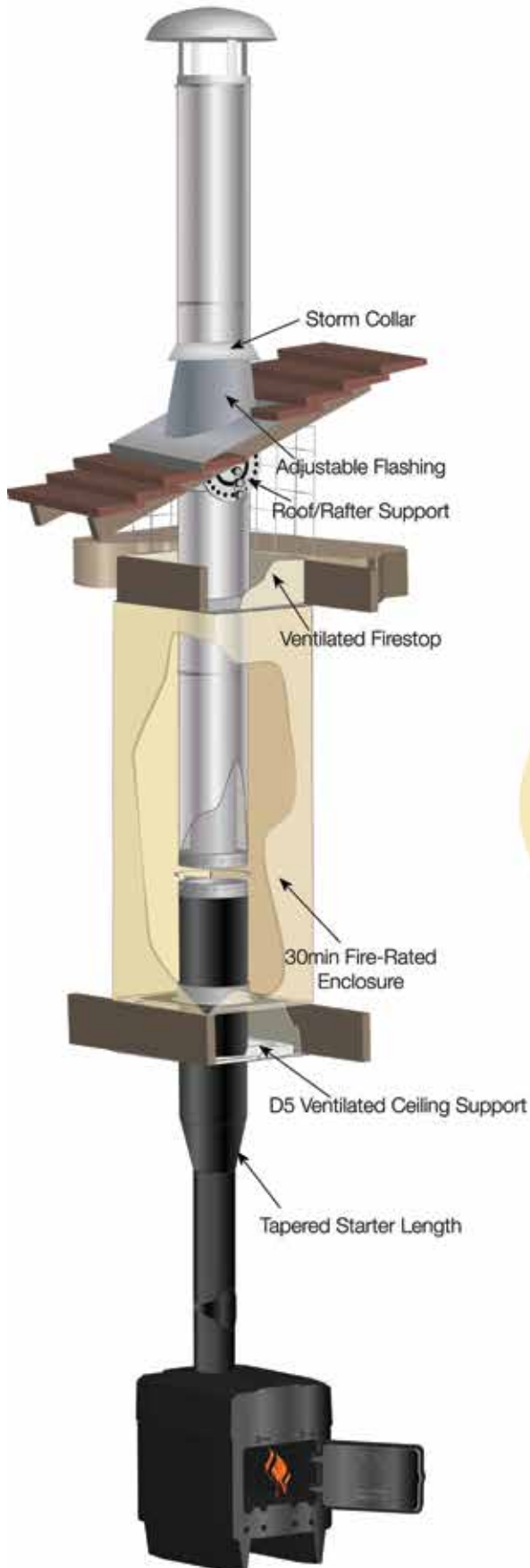

External System Chimney

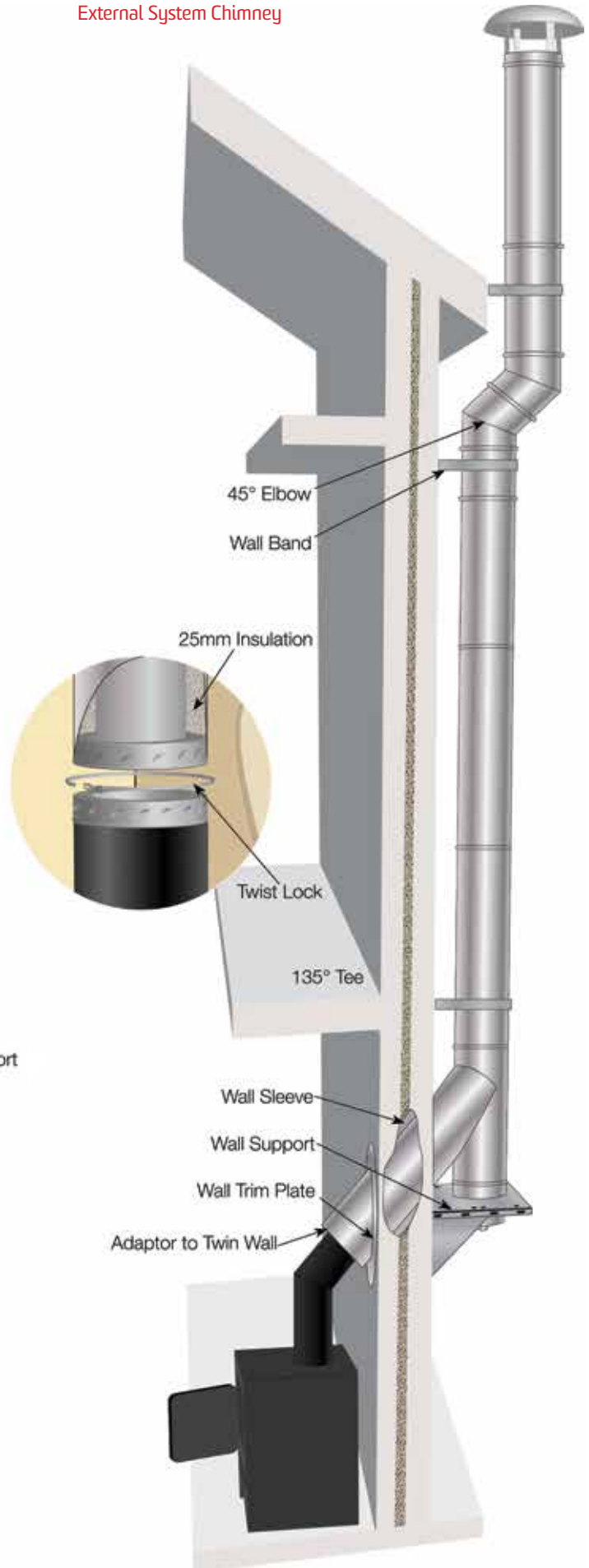

Image courtesy of SFL

Nova Matt Black

Suitable for: Woodburning, Solid Fuel, Gas & Oil

Designation Number: T450 N1 D V2 L50050 GSO (without seals) , T200 P1 W V2 L50050 050 (with seals)

Condensing	Locking Bands Req.	Locking Bands Inc.	Distance to Combustibles	Material	Insulation Thickness	Manufacturer	Manufactured in the UK	Warranty
✓ (add seals)	✓	✓	50mm	316 / 304 Stainless Steel	25mm	SFL	✓	20 years

Product Description	Diameter	Part No.	Price
---------------------	----------	----------	-------

Starting Components

	Appliance Adaptor Used to connect from an appliance or connecting flue pipe to Nova chimney system	130mm	1105094MB	£50.65
		150mm	1106094MB	£53.62
		200mm	1108094MB	£64.77

	Appliance Adaptor (Imperial) Used for connecting imperial sized spigots on appliances or connecting flue pipe	130mm	1105095MB	£39.61
---	---	-------	-----------	--------

	Anchor / Mounting Plate Used to connect Nova to a lintel or pre-cast chamber Square plate with single wall spigot below	130mm	1105527MB	£103.62
		150mm	1106527MB	£127.69
		200mm	1108527MB	£151.94

	Supra - Nova Adaptor Supra connecting flue pipe to Nova chimney system	130mm	1105096MB	£60.72
		150mm	1106096MB	£66.50
		200mm	1108096MB	£83.96

	Supra - Nova Increasing Adaptor Supra connecting flue pipe to larger diameter Nova chimney system	130 - 150mm	1106098MB	£102.96
---	---	-------------	-----------	---------

	Starter Length Black 996mm Installed length tapered Starter Length Can connect from the appliance outlet or connecting flue pipe	130mm	1105103	£177.56
		150mm	1106103	£192.65
		200mm	1108103	£220.23

Pipes

	1000mm Straight Length Standard straight length of flue	130mm	1105002MB	£202.60
		150mm	1106002MB	£222.07
		200mm	1108002MB	£276.62

	500mm Straight Length Standard straight length of flue	130mm	1105005MB	£151.89
		150mm	1106005MB	£159.70
		200mm	1108005MB	£197.72

	250mm Straight Length Standard straight length of flue	130mm	1105012MB	£110.02
		150mm	1106012MB	£111.57
		200mm	1108012MB	£131.95

Product Description	Diameter	Part No.	Price
---------------------	----------	----------	-------

	120mm Straight Length Standard straight length of flue	130mm	1105006MB	£87.98
		150mm	1106006MB	£93.23
		200mm	1108006MB	£110.44

	Adjustable Length - Long Two piece adjustable length 310 - 500mm adjustment Two seals required for positive pressure or wet systems	130mm	1105015MB	£177.06
		150mm	1106015MB	£186.03
		200mm	1108015MB	£220.15

	Adjustable Length - Short Two piece adjustable length 210 - 320mm adjustment Two seals required for positive pressure or wet systems	130mm	1105018MB	£174.31
		150mm	1106018MB	£177.41
		200mm	1108018MB	£212.15

Elbows / Tees

	90° Equal Tee Designed to connect from connecting flue pipe to a chimney system or the branch may be used to locate a draft stabiliser	130mm	1105043MB	£257.26
		150mm	1106043MB	£278.16
		200mm	1108043MB	£342.84







	135° Tee Designed to be used in combination with a 45° bend from connecting flue pipe to a chimney system	130mm	1105044MB	£428.69
		150mm	1106044MB	£453.82
		200mm	1108044MB	£571.36

	Locking Plug Used to close off the base or branch of a tee piece for inspection access	130mm	1105091MB	£112.41
		150mm	1106091MB	£117.86
		200mm	1108091MB	£135.67

	Condensate Collector (Drain Tee Cap) Used at the base of a vertical chimney to allow drainage of condensate from the system Fitted with a BSP drain connection	130mm	1105532MB	£127.02
		150mm	1106532MB	£132.61
		200mm	1108532MB	£144.84

	15° Bend Used for changing flue direction	130mm	1105025MB	£154.04
		150mm	1106025MB	£165.05
		200mm	1108025MB	£191.68

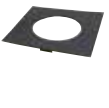
Product Description	Diameter	Part No.	Price
 30° Bend Used for changing flue direction	130mm	1105024MB	£154.04
	150mm	1106024MB	£165.05
	200mm	1108024MB	£191.68
 45° Bend Used for changing flue direction	130mm	1105022MB	£154.04
	150mm	1106022MB	£165.05
	200mm	1108022MB	£191.68
 90° Bend Used for changing flue direction	130mm	1105021MB	£256.23
	150mm	1106021MB	£266.77
	200mm	1108021MB	£305.81
Support / Penetration Components			
 Support Length 117mm Installed length with an incorporated plate with slotted holes for rotational adjustment	130mm	1105004MB	£158.01
	150mm	1106004MB	£187.29
	200mm	1108004MB	£212.91
 Locking Band Used to fasten around all joints Included with each component with a female coupler	130mm	1105086MB	£11.21
	150mm	1106086MB	£11.34
	200mm	1108086MB	£11.95
 Joint Sealing Ring Use on every joint for condensing applications	130mm	1105832	£2.18
	150mm	1106832	£2.56
	200mm	1108832	£2.91
 SFL Universal Lubricant Used in conjunction with joint sealing ring		1105833	£26.16
 Wall Support Bracket St/St (Support Length Included) Standard wall support offering 50mm from wall distance, includes support length, plate & triangular side plates (internal & external use)	130mm	1105061MB	£235.85
	150mm	1106061MB	£271.74
	200mm	1108061MB	£319.42
 Wall Support Bracket Galv (Support Length Included) Standard wall support offering 50mm from wall distance, includes support length, plate & triangular side plates (internal use)	130mm	1105062MB	£171.34
	150mm	1106062MB	£193.20
	200mm	1108062MB	£216.91
 Wall Support Short – up to 145mm Wall Support offering extension from the wall Internal & external use	130mm	1105031MB	£176.83
	150mm	1106031MB	£181.36
 Wall Support Long – up to 350mm Wall Support offering extension from the wall Internal & external use	130mm	1105032MB	£183.64
	150mm	1106032MB	£188.17

Product Description	Diameter	Part No.	Price
 Galvanised Wall Band Galvanised Wall Band to provide lateral support at a 50mm distance from the wall, for internal use	130mm	1105088MB	£30.94
	150mm	1106088MB	£31.40
	200mm	1108088MB	£32.31
 Stainless Steel Wall Band Stainless Steel Wall Band to provide lateral support at a 50mm distance from the wall, for internal & external use	130mm	1105067MB	£37.29
	150mm	1106067MB	£38.09
	200mm	1108067MB	£40.24
 Wall Band With Short Extension – 55 – 295mm Lateral support Wall Band offering adjustable extension from the wall	130mm	1105065MB	£73.66
	150mm	1106065MB	£75.38
	200mm	1108065MB	£81.61
 Wall Band With Long Extension – 55 – 500mm Lateral support Wall Band offering adjustable extension from the wall	130mm	1105069MB	£80.03
	150mm	1106069MB	£81.61
	200mm	1108069MB	£78.79
 Ceiling Support (T250) Provides support and a 50mm air gap clearance to a penetrated floor or ceiling and is only used where the chimney passes through non-combustible floors and / or services a gas or oil fired appliance where the flue gas does not exceed 250°C	130mm	1105027MB	£46.47
	150mm	1106027MB	£56.67
	200mm	1108027MB	£90.68
 Firestop Spacer (T250) Used where chimney passes through non-combustible floors and / or serves a gas or oil fired appliance where the flue gas does not exceed 250°C – not load bearing	130mm	1105087MB	£8.50
	150mm	1106087MB	£9.41
	200mm	1108087MB	£12.59
 Ventilated Firestop (Solid Fuel / Oil > 250°C) Used where chimney passes through combustible floors and where sections are enclosed in a non combustible shaft – not load bearing	130mm	1105082MB	£99.75
	150mm	1106082MB	£109.95
	200mm	1108082MB	£146.51

Product Description	Diameter	Part No.	Price
 Ventilated Ceiling Support (Solid Fuel / Oil) >250°C Used to both support & firestop the chimney system Code 1105083 Fire Rated Acrylic Sealant to be used	130mm	1105106	£109.80
	150mm	1106106	£115.74
	200mm	1108106	£129.12

 Fire Rated Acrylic Sealant Must be used for Ventilated Firestop / Ceiling Supports A substantial bead to be applied to the upper surface of the lower firestop plate in the groove before the foil matrix	1105083	£14.06
--	---------	---------------

 Guy Wire Bracket Used to secure unsupported chimney sections above the roof level in conjunction with wires or rigid stays.	130mm	1105092MB	£26.02
	150mm	1106092MB	£28.13
	200mm	1108092MB	£37.98

 0 – 10° Angled Wall Cover Ring Two piece elliptical collar allowing multiple angles between 0–10° for when chimney system passes through a roof eg vaulted ceilings, single storey extensions	130mm	1105110MB	£44.21
	150mm	1106110MB	£50.16
	200mm	1108110MB	£56.00

Product Description	Diameter	Part No.	Price
 10 – 20° Angled Wall Cover Ring Two piece elliptical collar allowing multiple angles between 10-20° for when chimney system passes through a roof eg vaulted ceilings, single storey extensions	130mm	1105120MB	£44.21
	150mm	1106120MB	£50.16
	200mm	1108120MB	£56.00

 30 – 40° Angled Wall Cover Ring Two piece elliptical collar allowing multiple angles between 30-40° for when chimney system passes through a roof eg vaulted ceilings, single storey extensions	130mm	1105140MB	£44.21
	150mm	1106140MB	£50.16
	200mm	1108140MB	£56.00

 40 – 50° Angled Wall Cover Ring Two piece elliptical collar allowing multiple angles between 40-50° for when chimney system passes through a roof eg vaulted ceilings, single storey extensions	130mm	1105150MB	£47.61
	150mm	1106150MB	£54.98
	200mm	1108150MB	£61.04









Product Description	Diameter	Part No.	Price
Terminals / Flashings			
 Top Stub (No Mesh) Open Terminal which offers the least resistance to flue gases, suitable for solid fuel appliances where drainage provision at the base	130mm	1105073MB	£67.39
	150mm	1106073MB	£70.20
	200mm	1108073MB	£89.32
 Top Stub (With Mesh) Open Terminal which offers the least resistance to flue gases, not suitable for high temperature appliances & needs drainage provision at the base	130mm	1105077MB	£136.29
	150mm	1106077MB	£155.44
	200mm	1108077MB	£166.68
 Round Top Similar to the raincap style but offers more protection against driving rain & wind	130mm	1105075MB	£120.21
	150mm	1106075MB	£128.23
	200mm	1108077MB	£154.65
 Rain Cap Designed to offer some protection from rain water	130mm	1105074MB	£57.51
	150mm	1106074MB	£60.01
	200mm	1108074MB	£82.72
 Storm Cowl Designed to offer the maximum protection against wind & driving rain (Not an antidowndraught terminal)	130mm	1105076MB	£108.81
	150mm	1106076MB	£118.80
	200mm	1108076MB	£127.60
 Storm Collar (Supplied With Sealant) Used to weather the top of the flashing, supplied with a tube of silicone sealant	130mm	1105041MB	£24.30
	150mm	1106041MB	£25.73
	200mm	1108041MB	£30.49

Did you know?

Nova now comes with a 20 year warranty

#designedtobebetter

Flex & Fittings

Product Description	Diameter	Part No.	Price	
Tecnoflex				
	316 Tecnoflex Plus Liner (per metre)	125mm	9705111	£109.73
	Twin skinned 316L grade stainless steel flexible liner. Lifetime warranty	155mm	9706111	£153.69
		180mm	9707111	£184.42
		200mm	9708111	£209.01
T450 N1 W V2 L50012 G				
	904 Tecnoflex Plus Liner (per metre)	125mm	9205904R	£166.03
	Twin skinned 904L grade stainless steel flexible liner. 25 year warranty	155mm	9206904R	£200.59
		180mm	9207904R	£228.04
		200mm	9208904R	£261.53
T450 N1 W V2 L70012 G				
Tecnoflex Fittings				
	Adaptor to Tecnoflex (screw / twist on)	125mm	1305090RV	£29.42
	Adaptor to connect between connecting flue pipe and Tecnoflex 316 or 904L liner	155mm	1306090RV	£34.29
		180mm	1307090RV	£39.20
		200mm	1308090RV	£44.10
		100 – 125mm	1305097RV	£35.59
	Sealant not required on high temperature applications	125 – 155mm	1306097RV	£40.68
	155 – 180mm	1307097RV	£44.10	
	180 – 200mm	1308097RV	£49.01	
	Nose Cone (screw / twist on for tecnoflex)	125mm	9505105S	£27.99
	Lightweight nose cone used to help pull the liner down the stack	155mm	9506105S	£27.99
		180mm	9507105S	£27.99
		200mm	9508105S	£27.99
	Pot Hanger (screw / twist on for tecnoflex)	125mm	9505041RV	£72.15
	Screw fit fastening on to top of liner used to hang liner from the chimney pot (up to 15m)	155mm	9506041RV	£74.24
	Pot Hanger and Terminal (screw / twist on for tecnoflex)	125mm	9505040RV	£129.22
	Screw fit fastening on to top of liner used to hang liner from the chimney pot with rain cap terminal attached. (up to 15m)	155mm	9506040RV	£137.83
	Joiner (screw / twist on for tecnoflex)	125mm	9505100S	£53.89
	Used to join two pieces of tecnoflex liner together.	155mm	9506100S	£58.80
		180mm	9507100S	£63.70
		200mm	9508100S	£68.61

Did you know?

316 Tecnoflex now comes with a lifetime guarantee.

#designedtobebetter

Screw Fit Illustration

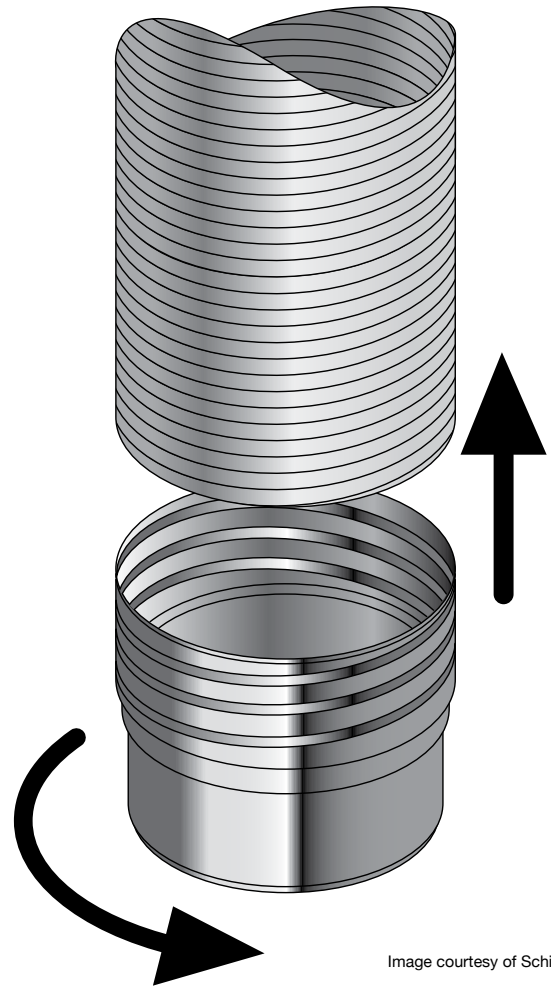

























Image courtesy of Schiedel

Product Description	Diameter	Part No.	Price	
Specflex				
	316 Specflex (per metre)	100mm	9604111	£104.33
	Twin skinned 316L grade stainless steel flexible liner. 10 year warranty	125mm	9605111	£111.27
		155mm	9606111	£155.83
		180mm	9607111	£186.99
		200mm	9608111	£211.93
T600 N1 W V2 L50012 G				
	904 Specflex (per metre)	125mm	9105904	£168.34
	Twin skinned 904L grade stainless steel flexible liner. 25 year warranty	155mm	9106904	£203.39
		180mm	9107904	£231.22
		200mm	9108904	£265.19
T600 N1 W V2 L70012 G				

Product Description	Diameter	Part No.	Price
Universal Fittings			
 Clamping Support Plate 375mm ² top plate with clamp attached used to hang liner on top of brick stack	125mm	9505112	£59.81
	155mm	9506112	£59.81
	180mm	9507112	£59.81
	200mm	9508112	£59.81
 Top Plate 375mm ² top plate used with top clamp used to support liner on top of brick stack	100mm	9504113	£47.04
	125mm	9505113	£45.23
	155mm	9506113	£45.36
	180mm	9507113	£45.36
	200mm	9508113	£45.36
 Top Clamp Used with top plate to support liner on top of brick stack	100mm	9504114	£27.68
	125mm	9505114	£28.82
	155mm	9506114	£28.82
	180mm	9507114	£41.82
 Top Insert Used to protect the top of the liner 194mm high	100mm	9504101	£27.76
	125mm	9505101	£27.76
	155mm	9506101	£30.27
	180mm	9507101	£35.36
	200mm	9508101	£45.44
 Top Insert 1000mm Long Used to protect the top of the liner with longer length	125mm	9505101E	£100.02
	155mm	9506101E	£111.18
	180mm	9507101E	£129.89
	200mm	9508101E	£130.75
 Adaptor to Flex (1mm Thick) Pushfit adaptor from connecting flue to flexible liner	100mm	1304090	£46.28
	125mm	1305090	£46.28
	155mm	1306090	£46.28
	180mm	1307090	£60.06
	200mm	1308090	£61.86
 Adaptor to Flex (Extended) Pushfit adaptor from connecting flue to flexible liner with 195mm tail	125mm	1305090T	£63.15
	155mm	1306090T	£69.49
	180mm	1307090T	£88.46
	200mm	1308090T	£97.94
 Increasing Adaptor to Flex Pushfit adaptor from connecting flue to flexible liner allowing an increase in diameter	100 – 125mm	1305097	£69.60
	100 – 150mm	1306096	£96.68
	125 – 155mm	1306097	£69.60
	155 – 180mm	1307097	£81.87
	180 – 200mm	1308097	£81.87
 Register Plate Adaptor to Flex 300mm ² Plate with pushfit adaptor	125mm	1305065	£104.09
	155mm	1306065	£109.75
	180mm	1307065	£127.14
	200mm	1308065	£136.08

Product Description	Diameter	Part No.	Price
 Increasing Register Plate Adaptor to Flex (300mm SQ Plate) 300mm ² plate with pushfit adaptor allowing an increase in diameter	100 – 125mm	1305066	£104.09
	125 – 155mm	1306066	£109.75
	155 – 180mm	1307066	£127.14
	180 – 200mm	1308066	£136.08
 Register Plate Slip Adaptor 300mm ² plate with pushfit adaptor. Underside allows connecting pipe to slip into the adaptor for a neat finish.	125mm	1305063	£95.47
	155mm	1306063	£95.47
 Bottom Support Bracket Used to fasten the liner to the wall of the masonry chimney to prevent lateral movement	125mm	9505028	£41.11
	155mm	9506028	£43.36
	180mm	9507028	£45.64
	200mm	9508028	£45.64
 Rain Cap (Top Insert Required) Used to help prevent excess water entering the chimney	125mm	9505074	£64.61
	155mm	9506074	£73.59
	180mm	9507074	£79.63
	200mm	9508074	£86.44
 Pot Hanger Easyfit fastening to top of liner used to hang liner from the chimney pot	100mm	9504041	£62.22
	125mm	9505041	£62.88
	155mm	9506041	£68.15
	180mm	9507041	£70.83
 Pot Hanging Cowl – S/S Terracotta All in one liner hanger from pot with rain & birdguard attached	125mm	3505001	£104.41
	155mm	3506001	£104.41
	180mm	3507001	£104.41
 Pot Hanging Cowl – S/S Buff All in one liner hanger from pot with rain & birdguard attached	125mm	3505001B	£104.41
	155mm	3506001B	£104.41
 S/S Nose Cone (Heavy Duty) 316 1mm stainless steel heavy duty nose cone used to help pull liner down chimney stack	125mm	9505105	£103.50
	155mm	9506105	£118.69
	180mm	9507105	£123.78
	200mm	9508105	£128.80

Product Description	Diameter	Part No.	Price
 Ali Nose Cone and Cord (Lightweight) Lightweight nose cone used to help pull the liner down the stack	100mm	9504105F	£9.57
	125mm	9505105F	£11.97
	155mm	9506105F	£11.97
	180mm	9507105F	£11.97
	200mm	9508105F	£11.97
 Joiner (Flex to Flex) Used to join two pieces of flexible liner together.	100mm	9504100	£53.36
	125mm	9505100	£53.96
	155mm	9506100	£58.93
	180mm	9507100	£63.03
	200mm	9508100	£65.46
 Sump Adaptor – 280mm Dish Used to attach stove connecting pipe to the underside of a masonry stack	125mm	1305087	£84.21
	155mm	1306087	£90.52
	180mm	1307087	£96.88
	200mm	1308087	£104.51
 Sump Adaptor – 330mm Dish Used to attach stove connecting pipe to the underside of a masonry stack	125mm	1305050	£84.21
	155mm	1306050	£90.52
	180mm	1307050	£96.88
	200mm	1308050	£104.51
 Adaptor to Clay Flue Liner Used to connect stove connecting pipe to clayliner	125 – 175mm	1305088	£140.38
	155 – 175mm	1306088	£140.38
	175mm	1307088	£140.38
	125 – 200mm	13050888	£140.38
	155 – 200mm	13060888	£140.38
	175 – 200mm	13070888	£140.38
	200mm	1308088	£140.38
	125 – 225mm	1305089	£140.38
	155 – 225mm	1306089	£140.38
	175 – 225mm	1307089	£140.38
	200 – 225mm	1308089	£140.38