

# Pellet

Sigma – Single Wall Matt Black	<b>2.2</b>
Nova – Twin Wall Chimney System	<b>2.4</b>
Nova Matt Black – Twin Wall Chimney System	<b>2.10</b>
Flexible Flue Liner & Fittings	<b>2.14</b>

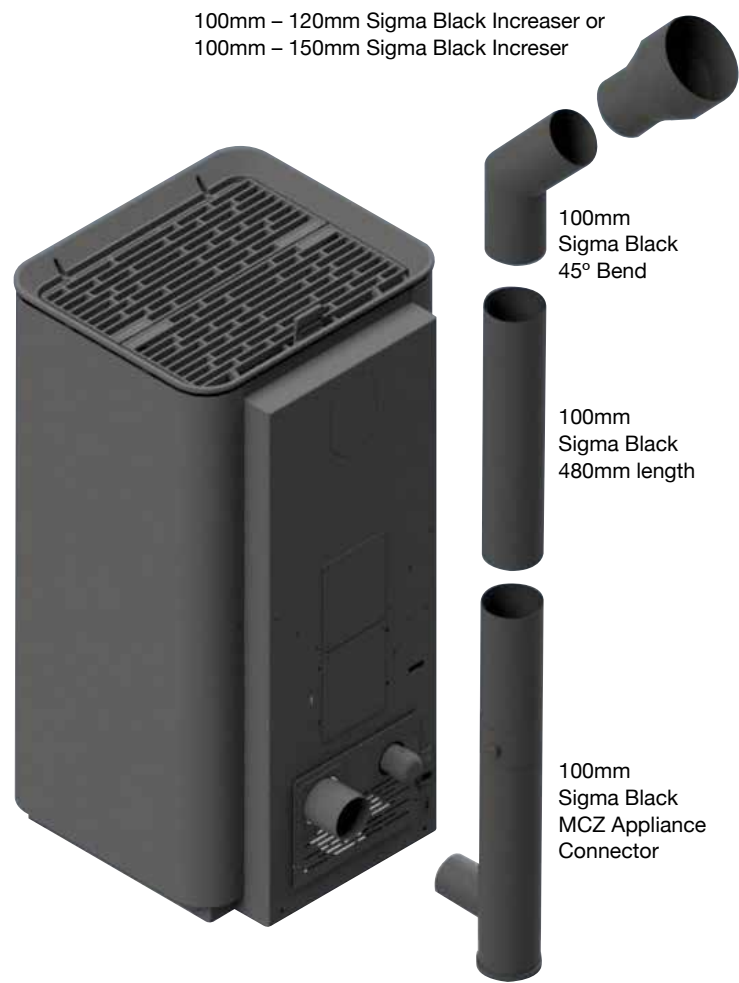

# Top & Rear Outlet

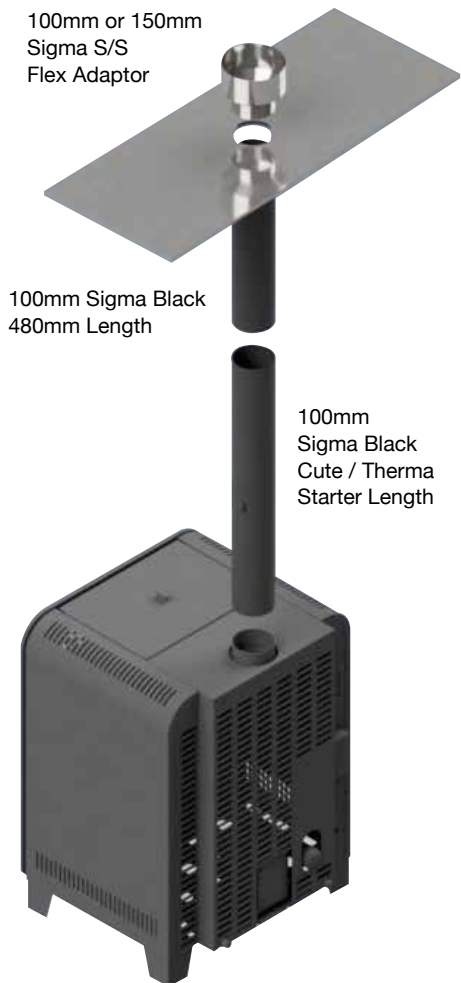











# Nova









Suitable for: Woodburning, Solid Fuel, Gas & Oil









Designation Number: T450 N1 D V2 L50050 GSO (without seals) , T200 P1 W V2 L50050 050 (with seals)

Condensing	Locking Bands Req.	Locking Bands Inc.	Distance to Combustibles	Material	Insulation Thickness	Manufacturer	Manufactured in the UK	Warranty
✓ (add seals)	✓	✓	50mm	316 / 304 Stainless Steel	25mm	SFL	✓	20 years







Product Description	Diameter	Part No.	Price
<b>Starting Components</b>			
 <b>Appliance Adaptor</b> Used to connect from an appliance or connecting flue pipe to Nova chimney system	100mm	1104094	£38.25
	130mm	1105094	£42.19
	150mm	1106094	£44.69
	180mm	1107094	£49.91
	200mm	1108094	£53.99
 <b>Appliance Adaptor (Imperial)</b> Used for connecting imperial sized spigots on appliances or connecting flue pipe	130mm	1105095	£33.02
	180mm	1107095	£41.44
 <b>Anchor / Mounting Plate</b> Used to connect Nova to a lintel or pre-cast chamber  Square plate with single wall spigot below	100mm	1104527	£79.06
	130mm	1105527	£86.37
	150mm	1106527	£106.43
	180mm	1107527	£113.97
 <b>Supra – Nova Adaptor</b> Supra connecting flue pipe to Nova chimney system	100mm	1104096	£46.55
	130mm	1105096	£50.64
	150mm	1106096	£55.43
	180mm	1107096	£63.48
	200mm	1108096	£69.97
 <b>Supra – Nova Increasing Adaptor</b> Supra connecting flue pipe to larger diameter Nova chimney system	100 – 130mm	1105098	£46.48
	130 – 150mm	1106098	£85.81
 <b>SM250 / SMW – Nova Adaptor</b> SFL S Flue to Nova chimney system adaptor	130mm	1105990	£86.61
	150mm	1106990	£93.52
	180mm	1107990	£101.39
	200mm	1108990	£108.62
 <b>Starter Length Stainless Steel</b> 996mm Installed length tapered Starter Length  Can connect from the appliance outlet or connecting flue pipe	130mm	1105101	£173.57
	150mm	1106101	£188.63
	180mm	1107101	£213.58
	200mm	1108101	£216.21
 <b>Starter Length White</b> 996mm Installed length tapered Starter Length  Can connect from the appliance outlet or connecting flue pipe	130mm	1105102	£177.56
	150mm	1106102	£192.65
	180mm	1107102	£217.61
	200mm	1108102	£220.23

Product Description	Diameter	Part No.	Price
<b>Pipes</b>			
 <b>1000mm Straight Length</b> Standard straight length of flue	100mm	1104002	£147.59
	130mm	1105002	£168.87
	150mm	1106002	£185.08
	180mm	1107002	£208.46
	200mm	1108002	£230.55
 <b>500mm Straight Length</b> Standard straight length of flue	100mm	1104005	£113.23
	130mm	1105005	£126.60
	150mm	1106005	£133.11
	180mm	1107005	£152.96
 <b>250mm Straight Length</b> Standard straight length of flue	100mm	1104012	£82.81
	130mm	1105012	£91.70
	150mm	1106012	£93.00
	180mm	1107012	£108.16
	200mm	1108012	£116.77
 <b>120mm Straight Length</b> Standard straight length of flue	100mm	1104006	£68.77
	130mm	1105006	£73.33
	150mm	1106006	£77.71
	180mm	1107006	£83.11
	200mm	1108006	£92.05
 <b>Adjustable Length – Long</b> Two piece adjustable length 310 – 500mm adjustment  Two seals required for positive pressure or wet systems	100mm	1104015	£142.26
	130mm	1105015	£147.58
	150mm	1106015	£155.05
	180mm	1107015	£167.05
 <b>Adjustable Length – Short</b> Two piece adjustable length 210 – 320mm adjustment  Two seals required for positive pressure or wet systems	100mm	1104018	£138.82
	130mm	1105018	£145.28
	150mm	1106018	£147.87
	180mm	1107018	£160.66
	200mm	1108018	£176.83
 <b>Inspection Length – Standard (N1/D)</b> 500mm installed length with access door for flue inspection for negative pressure / dry systems only	130mm	1105013	£564.97
	150mm	1106013	£586.67
	180mm	1107013	£597.42
	200mm	1108013	£622.36

Product Description	Diameter	Part No.	Price
 <b>Duct Drain Length</b> Used in an incline position to trap condensate and allow drainage Fitted with a standard s/s BSP thread connection and incorporates an internal back flow dam	100mm	1104009	<b>£176.94</b>
	130mm	1105009	<b>£197.04</b>
	150mm	1106009	<b>£196.46</b>
	180mm	1107009	<b>£219.15</b>
	200mm	1108009	<b>£230.85</b>
 <b>Probe Length</b> Used to allow flue gas analysis the length is supplied with a M16 threaded washer and bolt Cover jacket supplied to cover sampling point when not in use	100mm	1104534	<b>£146.32</b>
	130mm	1105534	<b>£150.70</b>
	150mm	1106534	<b>£160.27</b>
	180mm	1107534	<b>£186.64</b>
	200mm	1108534	<b>£189.87</b>
<b>Elbows / Tees</b>			
 <b>90° Equal Tee</b> Designed to connect from connecting flue pipe to a chimney system or the branch may be used to locate a draft stabiliser	100mm	1104043	<b>£212.98</b>
	130mm	1105043	<b>£214.43</b>
	150mm	1106043	<b>£231.84</b>
	180mm	1107043	<b>£262.08</b>
	200mm	1108043	<b>£285.75</b>
 <b>H&amp;S Stabiliser Adaptor</b> Adaptor from Nova tee branch to H & S Energy Draught Regulator	100 – 130mm	1104099	<b>£90.38</b>
	130mm	1105099	<b>£62.64</b>
	150mm	1106099	<b>£78.97</b>
	180 – 150mm	1107099	<b>£97.52</b>
	200mm	1108099	<b>£97.00</b>
 <b>95° Tee</b> Designed to connect from connecting flue pipe to a chimney system or for horizontal header configurations	100mm	1104042	<b>£222.22</b>
	130mm	1105042	<b>£229.61</b>
	150mm	1106042	<b>£250.42</b>
	180mm	1107042	<b>£280.74</b>
	200mm	1108042	<b>£309.15</b>
 <b>135° Tee</b> Designed to be used in combination with a 45° bend from connecting flue pipe to a chimney system	100mm	1104044	<b>£285.77</b>
	130mm	1105044	<b>£357.29</b>
	150mm	1106044	<b>£378.25</b>
	180mm	1107044	<b>£443.05</b>
	200mm	1108044	<b>£476.22</b>
 <b>Locking Plug</b> Used to close off the base or branch of a tee piece for inspection access	100mm	1104091	<b>£91.39</b>
	130mm	1105091	<b>£93.69</b>
	150mm	1106091	<b>£98.23</b>
	180mm	1107091	<b>£103.42</b>
	200mm	1108091	<b>£113.08</b>
 <b>Condensate Collector (Drain Tee Cap)</b> Used at the base of a vertical chimney to allow drainage of condensate from the system Fitted with a BSP drain connection	100mm	1104532	<b>£101.64</b>
	130mm	1105532	<b>£105.87</b>
	150mm	1106532	<b>£110.53</b>
	180mm	1107532	<b>£115.60</b>
	200mm	1108532	<b>£120.73</b>

Product Description	Diameter	Part No.	Price
 <b>15° Bend</b> Used for changing flue direction	100mm	1104025	<b>£125.02</b>
	130mm	1105025	<b>£128.38</b>
	150mm	1106025	<b>£137.57</b>
	180mm	1107025	<b>£145.25</b>
	200mm	1108025	<b>£159.75</b>
 <b>30° Bend</b> Used for changing flue direction	100mm	1104024	<b>£125.02</b>
	130mm	1105024	<b>£128.38</b>
	150mm	1106024	<b>£137.57</b>
	180mm	1107024	<b>£145.25</b>
	200mm	1108024	<b>£159.75</b>
 <b>45° Bend</b> Used for changing flue direction	100mm	1104022	<b>£125.02</b>
	130mm	1105022	<b>£128.38</b>
	150mm	1106022	<b>£137.57</b>
	180mm	1107022	<b>£145.25</b>
	200mm	1108022	<b>£159.75</b>
 <b>85° Bend</b> Used for changing flue direction	100mm	1104020	<b>£212.09</b>
	130mm	1105020	<b>£216.51</b>
	150mm	1106020	<b>£224.58</b>
	180mm	1107020	<b>£239.47</b>
	200mm	1108020	<b>£263.55</b>
 <b>90° Bend</b> Used for changing flue direction	100mm	1104021	<b>£210.41</b>
	130mm	1105021	<b>£213.55</b>
	150mm	1106021	<b>£222.34</b>
	180mm	1107021	<b>£240.55</b>
	200mm	1108021	<b>£254.89</b>
 <b>90° Inspection Elbow</b> Used for changing flue direction with inspection access door	130mm	1105019	<b>£348.22</b>
	150mm	1106019	<b>£360.30</b>
	180mm	1107019	<b>£375.85</b>
	200mm	1108019	<b>£387.89</b>
	<b>Support / Penetration Components</b>		
 <b>Support Length</b> 117mm Installed length with an incorporated plate with slotted holes for rotational adjustment	100mm	1104004	<b>£125.57</b>
	130mm	1105004	<b>£131.70</b>
	150mm	1106004	<b>£156.10</b>
	180mm	1107004	<b>£157.72</b>
	200mm	1108004	<b>£177.46</b>
 <b>Roof / Rafter Support</b> Flue band with adjustable and locking gimbal plates to support the chimney on roof joists or trussed rafters See Nova brochure for support info	100mm	1104029	<b>£77.47</b>
	130mm	1105029	<b>£78.05</b>
	150mm	1106029	<b>£78.41</b>
	180mm	1107029	<b>£78.99</b>
	200mm	1108029	<b>£79.36</b>
 <b>Locking Band</b> Used to fasten around all joints Included with each component with a female coupler	100mm	1104086	<b>£8.88</b>
	130mm	1105086	<b>£9.35</b>
	150mm	1106086	<b>£9.44</b>
	180mm	1107086	<b>£9.57</b>
	200mm	1108086	<b>£9.96</b>

Product Description	Diameter	Part No.	Price
 <b>Joint Sealing Ring</b> Use on every joint for condensing applications	100mm	1104832	£1.87
	130mm	1105832	£2.18
	150mm	1106832	£2.56
	180mm	1107832	£2.71
	200mm	1108832	£2.91
 <b>SFL Universal Lubricant</b> Used in conjunction with joint sealing ring		1105833	£26.16
 <b>Wall Support Bracket St/St (Support Length Included)</b> Standard wall support offering 50mm from wall distance, includes support length, plate & triangular side plates	100mm	1104061	£183.31
	130mm	1105061	£196.58
	150mm	1106061	£226.48
	180mm	1107061	£244.50
	200mm	1108061	£266.23
 <b>Wall Support Bracket Galv (Support Length Included)</b> Galvanised version for internal use Internal & external use	100mm	1104062	£134.38
	130mm	1105062	£142.81
	150mm	1106062	£161.03
	180mm	1107062	£166.28
 <b>Wall Support Short – up to 145mm</b> Wall Support offering extension from the wall Internal & external use	100mm	1104031	£145.65
	130mm	1105031	£150.36
	150mm	1106031	£154.20
	180mm	1107031	£160.75
 <b>Wall Support Long – up to 350mm</b> Wall Support offering extension from the wall Internal & external use	100mm	1104032	£151.54
	130mm	1105032	£156.24
	150mm	1106032	£160.07
	180mm	1107032	£166.62
 <b>Galvanised Wall Band</b> Galvanised Wall Band to provide lateral support at a 50mm distance from the wall, for internal use.	100mm	1104088	£25.30
	130mm	1105088	£22.59
	150mm	1106088	£26.07
	180mm	1107088	£26.43
 <b>Stainless Steel Wall Band</b> Stainless Steel Wall Band to provide lateral support at a 50mm distance from the wall, for internal & external use.	100mm	1104067	£29.42
	130mm	1105067	£27.22
	150mm	1106067	£31.71
	180mm	1107067	£32.66
 <b>Wall Band With Short Extension – 55 – 295mm</b> Lateral support Wall Band offering adjustable extension from the wall	100mm	1104065	£60.12
	130mm	1105065	£62.67
	150mm	1106065	£64.90
	180mm	1107065	£67.82
	200mm	1108065	£70.16

Product Description	Diameter	Part No.	Price
 <b>Wall Band With Long Extension – 55 – 500mm</b> Lateral support Wall Band offering adjustable extension from the wall	100mm	1104069	£65.59
	130mm	1105069	£68.03
	150mm	1106069	£70.26
	180mm	1107069	£73.17
	200mm	1108069	£75.52
 <b>Ceiling Support (T250)</b> Provides support and a 50mm air gap clearance to a penetrated floor or ceiling and is only used where the chimney passes through non-combustible floors and / or services a gas or oil fired appliance where the flue gas does not exceed 250°C	100mm	1104027	£35.38
	130mm	1105027	£37.64
	150mm	1106027	£41.87
	180mm	1107027	£43.95
	200mm	1108027	£66.23
 <b>Firestop Spacer (T250)</b> Used where chimney passes through non-combustible floors and / or serves a gas or oil fired appliance where the flue gas does not exceed 250°C – not load bearing	100mm	1104087	£5.54
	130mm	1105087	£6.44
	150mm	1106087	£7.18
	180mm	1107087	£8.10
	200mm	1108087	£9.61
 <b>D5 White Ventilated Ceiling Support</b> Used to both support & firestop the chimney system Offers an aesthetically pleasing flat appearance Fire Rated Acrylic Sealant to be used	100mm	1104108	£125.45
	130mm	1105108	£135.56
	150mm	1106108	£142.89
	180mm	1107108	£157.53
	200mm	1108108	£159.41
 <b>Ventilated Ceiling Support (T450) St/St</b> Vented Ceiling Support used to both support & firestop the chimney system Fire Rated Acrylic Sealant to be used	100mm	1104107	£98.48
	130mm	1105107	£109.80
	150mm	1106107	£115.74
	180mm	1107107	£127.60
	200mm	1108107	£129.10
 <b>Ventilated Ceiling Support (T450) White</b> Vented Ceiling Support used to both support & firestop the chimney system Fire Rated Acrylic Sealant to be used	100mm	1104105	£98.48
	130mm	1105105	£109.80
	150mm	1106105	£115.74
	180mm	1107105	£127.60
	200mm	1108105	£129.12
 <b>Ventilated Firestop (T450)</b> Used where chimney passes through combustible floors and where sections are enclosed in a non combustible shaft – not load bearing	100mm	1104082	£65.22
	130mm	1105082	£72.28
	150mm	1106082	£79.32
	180mm	1107082	£90.75
	200mm	1108082	£105.76



# Do you need?

Guy Wire, Grips and Strainers or Rigid Roof Stays



See the Fixings section on page 7.10

Product Description	Diameter	Part No.	Price
 <b>Flue Enclosure Kit 2400mm</b> 2 x 1200mm long mesh enclosures with bands and fittings, designed to be used within a loft space to ensure distance & ventilation around chimney system	130mm	1105557	£215.72
	150mm	1106557	£215.72
	180mm	1107557	£215.72
	200mm	1108557	£215.72
 <b>Guy Wire Bracket</b> Used to secure unsupported chimney sections above the roof level in conjunction with wires or rigid stays	130mm	1105092	£18.95
	150mm	1106092	£20.46
	180mm	1107092	£22.63
	200mm	1108092	£25.18
 <b>Fire Rated Acrylic Sealant</b> Must be used for Ventilated Firestop / Ceiling Supports A substantial bead to be applied to the upper surface of the lower firestop plate in the groove before the foil matrix	—	1105083	£14.06
 <b>Standard Horizontal Wall Trim Collar (St/St)</b> Polished stainless steel one piece trim collar Offering a nominal 105mm wide circular flange used to neaten where the chimney system passes through the wall	100mm	1104085	£24.24
	130mm	1105085	£25.79
	150mm	1106085	£27.55
	180mm	1107085	£29.50
	200mm	1108085	£31.48
 <b>0 – 10° Angled Wall Cover Ring</b> Two piece elliptical collar allowing multiple angles between 0 – 10° for when chimney systems passes through a roof eg vaulted ceilings, single storey extensions	130mm	1105110	£30.17
	150mm	1106110	£34.27
	180mm	1107110	£35.53
	200mm	1108110	£38.22

Product Description	Diameter	Part No.	Price
 <b>10 – 20° Angled Wall Cover Ring</b> Two piece elliptical collar allowing multiple angles between 10 – 20° for when chimney systems passes through a roof eg vaulted ceilings, single storey extensions	130mm	1105120	£30.17
	150mm	1106120	£34.27
	180mm	1107120	£35.53
	200mm	1108120	£38.22
 <b>30 – 40° Angled Wall Cover Ring</b> Two piece elliptical collar allowing multiple angles between 30 – 40° for when chimney systems passes through a roof eg vaulted ceilings, single storey extensions	130mm	1105140	£30.17
	150mm	1106140	£34.27
	180mm	1107140	£35.53
	200mm	1108140	£38.22
 <b>40 – 50° Angled Wall Cover Ring</b> Two piece elliptical collar allowing multiple angles between 40 – 50° for when chimney systems passes through a roof eg vaulted ceilings, single storey extensions	130mm	1105150	£30.17
	150mm	1106150	£34.27
	180mm	1107150	£35.53
	200mm	1108150	£38.22
 <b>135° Wall Sleeve (Combustible Wall)</b> Mitred sleeve used to protect the building where the flue passes through	100mm	1104050	£88.92
	130mm	1105050	£41.62
	150mm	1106050	£78.41
	180mm	1107050	£78.41
 <b>135° Wall Sleeve (Non Combustible Wall)</b> Mitred sleeve used to protect the building where the flue passes through	100mm	1104051	£88.92
	130mm	1105051	£41.62
	150mm	1106051	£78.41
	180mm	1107051	£78.41
<b>Terminals / Flashings</b>			
 <b>Adaptor to Flexible</b> Top Adaptor from Nova Chimney System to Flexible Liner	100mm	1104063	£37.23
	130mm	1105063	£42.58
	150mm	1106063	£48.85
	180mm	1107063	£53.99
 <b>Nova to SM250 / SMW adaptor / S Flue</b> Nova Chimney System to S Flue adaptor	130mm	1105991	£86.61
	150mm	1106991	£93.52
	180mm	1107991	£101.39
	200mm	1108991	£111.88
 <b>Nova to Supra Adaptor</b> Top Adaptor from Nova Chimney System to Supra Chimney System	100mm	1104097	£49.50
	130mm	1105097	£55.94
	150mm	1106097	£60.10
	180mm	1107097	£68.05
	200mm	1108097	£74.94

Product Description	Diameter	Part No.	Price
<b>Top Stub (No Mesh)</b> Open Terminal which offers the least resistance to flue gases, suitable for solid fuel appliances where drainage provision at the base	100mm	1104073	£54.26
	130mm	1105073	£56.17
	150mm	1106073	£58.51
	180mm	1107073	£61.15
	200mm	1108073	£76.70
<b>Top Stub (With Mesh)</b> Open Terminal which offers the least resistance to flue gases, not suitable for high temperature appliances & needs drainage provision at the base	100mm	1104077	£107.28
	130mm	1105077	£113.60
	150mm	1106077	£129.55
	180mm	1107077	£133.76
	200mm	1108077	£143.09
<b>Round Top</b> Similar to the raincap style but offers more protection against driving rain & wind	100mm	1104075	£58.09
	130mm	1105075	£100.19
	150mm	1106075	£106.88
	180mm	1107075	£115.91
	200mm	1108075	£132.77
<b>Rain Cap</b> Designed to offer some protection from rain water	100mm	1104074	£46.28
	130mm	1105074	£47.95
	150mm	1106074	£50.01
	180mm	1107074	£55.74
	200mm	1108074	£71.00
<b>Storm Cowl</b> Designed to offer the maximum protection against wind & driving rain (Not an antidowndraught terminal)	100mm	1104076	£81.93
	130mm	1105076	£90.69
	150mm	1106076	£99.02
	180mm	1107076	£100.20
	200mm	1108076	£109.55
<b>Flat Flashing</b> Aluminium flat roof flashing	100mm	1104038	£41.80
	130mm	1105038	£39.93
	150mm	1106038	£42.19
	180mm	1107038	£47.46
	200mm	1108038	£50.42
<b>Adjustable Flashing 5 – 30°</b> Aluminium angled roof flashing	130mm	1105035	£39.93
	150mm	1106035	£42.19
	180mm	1107035	£47.46
	200mm	1108035	£50.42
<b>Adjustable Flashing 32–45°</b> Aluminium angled roof flashing	130mm	1105036	£47.46
	150mm	1106036	£50.42
	180mm	1107036	£65.25
	200mm	1108036	£68.22
<b>Storm Collar (Supplied With Sealant)</b> Used to weather the top of the flashing, supplied with a tube of silicone sealant	100mm	1104041	£19.29
	130mm	1105041	£20.04
	150mm	1106041	£21.40
	180mm	1107041	£24.48
	200mm	1108041	£25.96

Nova Mitred Bend Dimensions

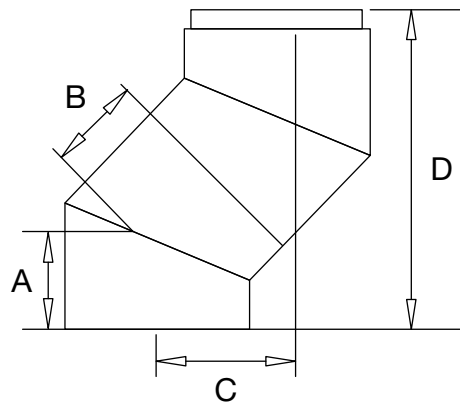

15° Elbow					
Diameter	100	130	150	180	200
A	91	98	102	108	112
B	100	111	111	123	128
C	47	51	53	56	58
D	358	385	401	425	440

30° Elbow					
Diameter	100	130	150	180	200
A	91	98	102	108	112
B	111	122	122	139	145
C	91	98	102	108	112
D	340	366	381	403	418

45° Elbow					
Diameter	100	130	150	180	200
A	91	98	102	108	112
B	118	131	131	149	157
C	129	139	144	153	158
D	311	335	348	369	382

Can't find what you're looking for?

Send us a drawing and we can get a quote to get it especially made for you.

#designedtobebetter

Do you need?

Exodraft Fans and Accessories

See page 7.2



# Typical Domestic Installation

Internal System Chimney

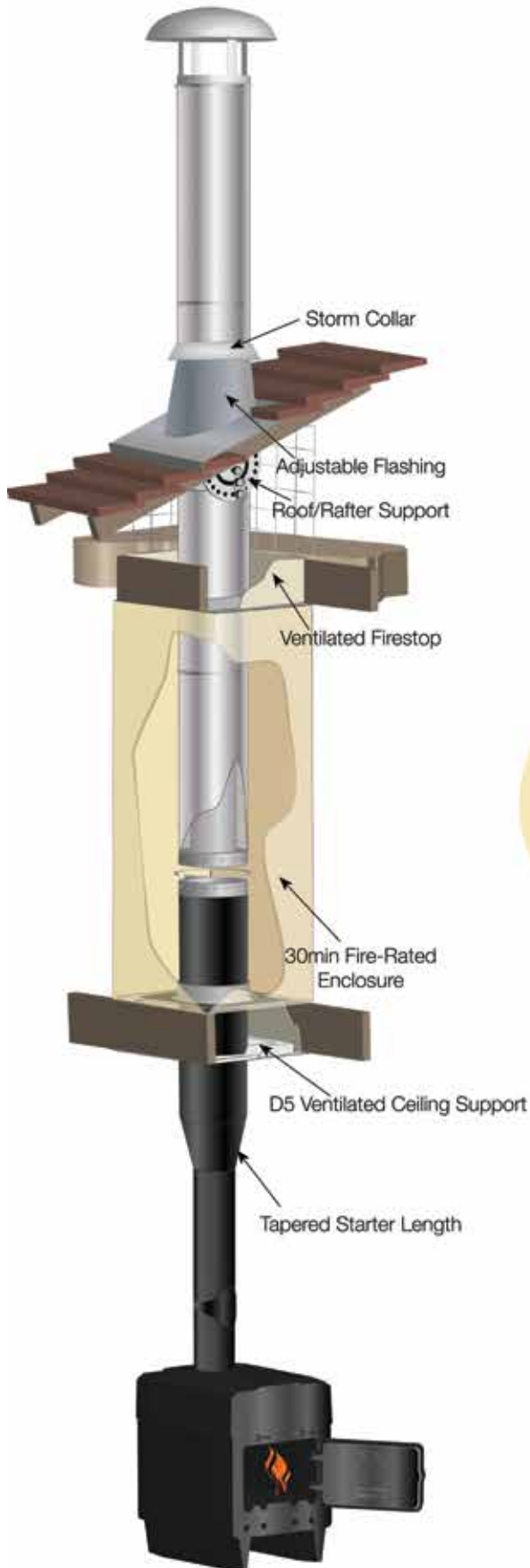

External System Chimney

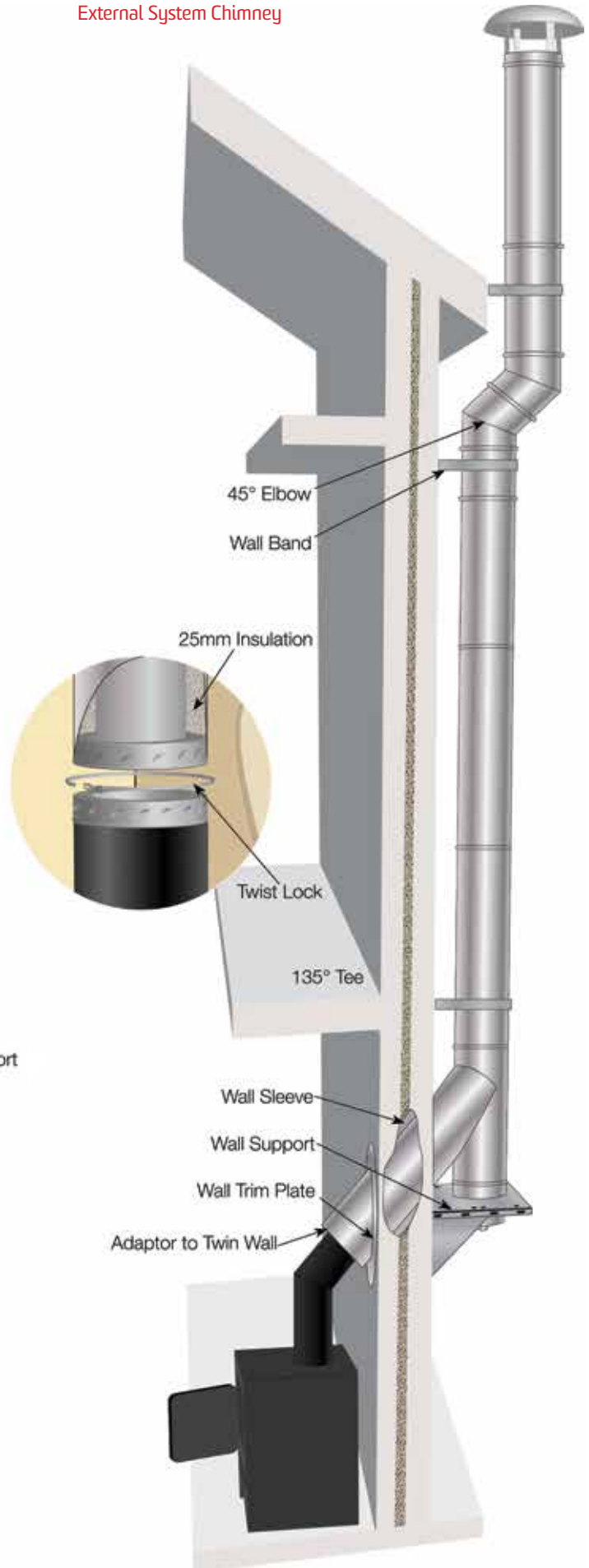

Image courtesy of SFL

# Nova Matt Black

Suitable for: Woodburning, Solid Fuel, Gas & Oil

Designation Number: T450 N1 D V2 L50050 GSO (without seals) , T200 P1 W V2 L50050 050 (with seals)

Condensing	Locking Bands Req.	Locking Bands Inc.	Distance to Combustibles	Material	Insulation Thickness	Manufacturer	Manufactured in the UK	Warranty
✓ (add seals)	✓	✓	50mm	316 / 304 Stainless Steel	25mm	SFL	✓	20 years

Product Description	Diameter	Part No.	Price
---------------------	----------	----------	-------

**Starting Components**

	<b>Appliance Adaptor</b> Used to connect from an appliance or connecting flue pipe to Nova chimney system	130mm	1105094MB	£50.65
		150mm	1106094MB	£53.62
		200mm	1108094MB	£64.77

	<b>Appliance Adaptor (Imperial)</b> Used for connecting imperial sized spigots on appliances or connecting flue pipe	130mm	1105095MB	£39.61
-----------------------------------------------------------------------------------	-------------------------------------------------------------------------------------------------------------------------	-------	-----------	--------

	<b>Anchor / Mounting Plate</b> Used to connect Nova to a lintel or pre-cast chamber	130mm	1105527MB	£103.62
		150mm	1106527MB	£127.69
		200mm	1108527MB	£151.94

Square plate with single wall spigot below

	<b>Supra - Nova Adaptor</b> Supra connecting flue pipe to Nova chimney system	130mm	1105096MB	£60.72
		150mm	1106096MB	£66.50
		200mm	1108096MB	£83.96

	<b>Supra - Nova Increasing Adaptor</b> Supra connecting flue pipe to larger diameter Nova chimney system	130 - 150mm	1106098MB	£102.96
-------------------------------------------------------------------------------------	-------------------------------------------------------------------------------------------------------------	-------------	-----------	---------

	<b>Starter Length Black</b> 996mm Installed length tapered Starter Length	130mm	1105103	£177.56
		150mm	1106103	£192.65
		200mm	1108103	£220.24

Can connect from the appliance outlet or connecting flue pipe

**Pipes**

	<b>1000mm Straight Length</b> Standard straight length of flue	130mm	1105002MB	£202.60
		150mm	1106002MB	£222.07
		200mm	1108002MB	£276.62

	<b>500mm Straight Length</b> Standard straight length of flue	130mm	1105005MB	£151.89
		150mm	1106005MB	£159.70
		200mm	1108005MB	£197.72

	<b>250mm Straight Length</b> Standard straight length of flue	130mm	1105012MB	£110.02
		150mm	1106012MB	£111.57
		200mm	1108012MB	£140.10

Product Description	Diameter	Part No.	Price
---------------------	----------	----------	-------

	<b>120mm Straight Length</b> Standard straight length of flue	130mm	1105006MB	£87.98
		150mm	1106006MB	£93.23
		200mm	1108006MB	£110.44

	<b>Adjustable Length - Long</b> Two piece adjustable length 310 - 500mm adjustment	130mm	1105015MB	£177.06
		150mm	1106015MB	£186.03
		200mm	1108015MB	£220.15

Two seals required for positive pressure or wet systems

	<b>Adjustable Length - Short</b> Two piece adjustable length 210 - 320mm adjustment	130mm	1105018MB	£174.31
		150mm	1106018MB	£177.41
		200mm	1108018MB	£212.15

Two seals required for positive pressure or wet systems

**Elbows / Tees**

	<b>90° Equal Tee</b> Designed to connect from connecting flue pipe to a chimney system or the branch may be used to locate a draft stabiliser	130mm	1105043MB	£257.26
		150mm	1106043MB	£278.16
		200mm	1108043MB	£342.84











	<b>135° Tee</b> Designed to be used in combination with a 45° bend from connecting flue pipe to a chimney system	130mm	1105044MB	£428.69
		150mm	1106044MB	£453.82
		200mm	1108044MB	£571.36







	<b>Locking Plug</b> Used to close off the base or branch of a tee piece for inspection access	130mm	1105091MB	£112.41
		150mm	1106091MB	£117.86
		200mm	1108091MB	£135.67

	<b>Condensate Collector (Drain Tee Cap)</b> Used at the base of a vertical chimney to allow drainage of condensate from the system	130mm	1105532MB	£127.02
		150mm	1106532MB	£132.61
		200mm	1108532MB	£144.84



Fitted with a BSP drain connection

	<b>15° Bend</b> Used for changing flue direction	130mm	1105025MB	£154.04
		150mm	1106025MB	£165.05
		200mm	1108025MB	£191.68

Product Description	Diameter	Part No.	Price
 <b>30° Bend</b> Used for changing flue direction	130mm	1105024MB	£154.04
	150mm	1106024MB	£165.05
	200mm	1108024MB	£191.68
 <b>45° Bend</b> Used for changing flue direction	130mm	1105022MB	£154.04
	150mm	1106022MB	£165.05
	200mm	1108022MB	£191.68
 <b>90° Bend</b> Used for changing flue direction	130mm	1105021MB	£256.23
	150mm	1106021MB	£266.77
	200mm	1108021MB	£305.81
<b>Support / Penetration Components</b>			
 <b>Support Length</b> 117mm Installed length with an incorporated plate with slotted holes for rotational adjustment	130mm	1105004MB	£158.01
	150mm	1106004MB	£187.29
	200mm	1108004MB	£212.91
 <b>Locking Band</b> Used to fasten around all joints Included with each component with a female coupler	130mm	1105086MB	£11.21
	150mm	1106086MB	£11.34
	200mm	1108086MB	£11.95
 <b>Joint Sealing Ring</b> Use on every joint for condensing applications	130mm	1105832	£2.18
	150mm	1106832	£2.56
	200mm	1108832	£2.91
 <b>SFL Universal Lubricant</b> Used in conjunction with joint sealing ring		1105833	£26.16
 <b>Wall Support Bracket St/St (Support Length Included)</b> Standard wall support offering 50mm from wall distance, includes support length, plate & triangular side plates	130mm	1105061MB	£235.85
	150mm	1106061MB	£271.74
	200mm	1108061MB	£319.42
 <b>Wall Support Bracket Galv (Support Length Included)</b> Galvanised version for internal use	130mm	1105062MB	£171.34
	150mm	1106062MB	£193.20
	200mm	1108062MB	£216.91
 <b>Wall Support Short – up to 145mm</b> Wall Support offering extension from the wall Internal & external use	130mm	1105031MB	£176.83
	150mm	1106031MB	£181.36
 <b>Wall Support Long – up to 350mm</b> Wall Support offering extension from the wall Internal & external use	130mm	1105032MB	£183.64
	150mm	1106032MB	£188.17

Product Description	Diameter	Part No.	Price
 <b>Galvanised Wall Band</b> Galvanised Wall Band to provide lateral support at a 50mm distance from the wall, for internal use	130mm	1105088MB	£30.94
	150mm	1106088MB	£31.40
	200mm	1108088MB	£32.31
 <b>Stainless Steel Wall Band</b> Stainless Steel Wall Band to provide lateral support at a 50mm distance from the wall, for internal & external use	130mm	1105067MB	£37.29
	150mm	1106067MB	£38.09
	200mm	1108067MB	£40.24
 <b>Wall Band With Short Extension – 55 – 295mm</b> Lateral support Wall Band offering adjustable extension from the wall	130mm	1105065MB	£73.66
	150mm	1106065MB	£75.38
	200mm	1108065MB	£81.61
 <b>Wall Band With Long Extension – 55 – 500mm</b> Lateral support Wall Band offering adjustable extension from the wall	130mm	1105069MB	£80.03
	150mm	1106069MB	£81.61
	200mm	1108069MB	£78.79
 <b>Ceiling Support (T250)</b> Provides support and a 50mm air gap clearance to a penetrated floor or ceiling and is only used where the chimney passes through non-combustible floors and / or services a gas or oil fired appliance where the flue gas does not exceed 250°C	130mm	1105027MB	£46.47
	150mm	1106027MB	£56.67
	200mm	1108027MB	£90.68
 <b>Firestop Spacer (T250)</b> Used where chimney passes through non-combustible floors and / or serves a gas or oil fired appliance where the flue gas does not exceed 250°C – not load bearing	130mm	1105087MB	£8.50
	150mm	1106087MB	£9.41
	200mm	1108087MB	£12.59
 <b>Ventilated Firestop (Solid Fuel / Oil &gt; 250°C)</b> Used where chimney passes through combustible floors and where sections are enclosed in a non combustible shaft – not load bearing	130mm	1105082MB	£99.75
	150mm	1106082MB	£109.95
	200mm	1108082MB	£146.51

Product Description	Diameter	Part No.	Price
 <b>Ventilated Ceiling Support (Solid Fuel / Oil) &gt;250°C</b> Used to both support & firestop the chimney system Code 1105083 Fire Rated Acrylic Sealant to be used	130mm	1105106	<b>£109.80</b>
	150mm	1106106	<b>£109.19</b>
	200mm	1108106	<b>£129.12</b>
 <b>Fire Rated Acrylic Sealant</b> Must be used for Ventilated Firestop / Ceiling Supports A substantial bead to be applied to the upper surface of the lower firestop plate in the groove before the foil matrix		1105083	<b>£14.06</b>
 <b>Guy Wire Bracket</b> Used to secure unsupported chimney sections above the roof level in conjunction with wires or rigid stays.	130mm	1105092MB	<b>£26.02</b>
	150mm	1106092MB	<b>£28.13</b>
	200mm	1108092MB	<b>£37.98</b>
 <b>0 – 10° Angled Wall Cover Ring</b> Two piece elliptical collar allowing multiple angles between 0 – 10° for when chimney systems passes through a roof eg vaulted ceilings, single storey extensions	130mm	1105110MB	<b>£44.21</b>
	150mm	1106110MB	<b>£50.16</b>
	200mm	1108110MB	<b>£56.00</b>

Product Description	Diameter	Part No.	Price
 <b>10 – 20° Angled Wall Cover Ring</b> Two piece elliptical collar allowing multiple angles between 10 – 20° for when chimney systems passes through a roof eg vaulted ceilings, single storey extensions	130mm	1105120MB	<b>£44.21</b>
	150mm	1106120MB	<b>£50.16</b>
	200mm	1108120MB	<b>£56.00</b>
 <b>30 – 40° Angled Wall Cover Ring</b> Two piece elliptical collar allowing multiple angles between 30 – 40° for when chimney systems passes through a roof eg vaulted ceilings, single storey extensions	130mm	1105140MB	<b>£44.21</b>
	150mm	1106140MB	<b>£50.16</b>
	200mm	1108140MB	<b>£56.00</b>
 <b>40 – 50° Angled Wall Cover Ring</b> Two piece elliptical collar allowing multiple angles between 40 – 50° for when chimney systems passes through a roof eg vaulted ceilings, single storey extensions	130mm	1105150MB	<b>£47.61</b>
	150mm	1106150MB	<b>£54.98</b>
	200mm	1108150MB	<b>£61.04</b>



Product Description	Diameter	Part No.	Price
<b>Terminals / Flashings</b>			
 <b>Top Stub (No Mesh)</b> Open Terminal which offers the least resistance to flue gases, suitable for solid fuel appliances where drainage provision at the base	130mm	1105073MB	<b>£67.39</b>
	150mm	1106073MB	<b>£70.20</b>
	200mm	1108073MB	<b>£89.32</b>
 <b>Top Stub (With Mesh)</b> Open Terminal which offers the least resistance to flue gases, not suitable for high temperature appliances & needs drainage provision at the base	130mm	1105077MB	<b>£136.29</b>
	150mm	1106077MB	<b>£155.44</b>
	200mm	1108077MB	<b>£166.68</b>
 <b>Round Top</b> Similar to the raincap style but offers more protection against driving rain & wind	130mm	1105075MB	<b>£120.21</b>
	150mm	1106075MB	<b>£128.23</b>
	200mm	1108077MB	<b>£154.65</b>
 <b>Rain Cap</b> Designed to offer some protection from rain water	130mm	1105074MB	<b>£57.51</b>
	150mm	1106074MB	<b>£60.01</b>
	200mm	1108074MB	<b>£82.72</b>
 <b>Storm Cowl</b> Designed to offer the maximum protection against wind & driving rain  (Not an antidowndraught terminal)	130mm	1105076MB	<b>£108.81</b>
	150mm	1106076MB	<b>£118.80</b>
	200mm	1108076MB	<b>£127.60</b>
 <b>Flat Flashing</b> Aluminium flat roof flashing	130mm	1105038MB	<b>£47.42</b>
	150mm	1106038MB	<b>£50.62</b>
	200mm	1108038MB	<b>£56.01</b>
 <b>Adjustable Flashing 5 – 30°</b> Aluminium angled roof flashing	130mm	1105035MB	<b>£47.42</b>
	150mm	1106035MB	<b>£50.62</b>
	200mm	1108035MB	<b>£56.01</b>
 <b>Adjustable Flashing 32–45°</b> Aluminium angled roof flashing	130mm	1105036MB	<b>£44.21</b>
	150mm	1106036MB	<b>£50.16</b>
	200mm	1108036MB	<b>£56.00</b>
 <b>Storm Collar (Supplied With Sealant)</b> Used to weather the top of the flashing, supplied with a tube of silicone sealant	130mm	1105041MB	<b>£24.30</b>
	150mm	1106041MB	<b>£25.73</b>
	200mm	1108041MB	<b>£30.49</b>

 **Did you know?**

Nova now comes with a 20 year warranty

#designedtobebetter

# Flex & Fittings

Product Description	Diameter	Part No.	Price
<b>Tecnoflex</b>			
 <b>316 Tecnoflex Plus Liner (per metre)</b> Twin skinned 316L grade stainless steel flexible liner Lifetime warranty	80mm	9703111	£90.12
	100mm	9704111	£97.06
	125mm	9705111	£103.52
	155mm	9706111	£144.99
	180mm	9707111	£173.98
	200mm	9708111	£197.18
 <b>904 Tecnoflex Plus Liner (per metre)</b> Twin skinned 904L grade stainless steel flexible liner 25 year warranty	125mm	9205904R	£156.63
	155mm	9206904R	£189.24
	180mm	9207904R	£215.13
	200mm	9208904R	£246.73
<b>Tecnoflex Fittings</b>			
 <b>Adaptor to Tecnoflex (screw / twist on)</b> Adaptor to connect between connecting flue pipe and Tecnoflex 316 or 904L liner. Sealant not required on high temperature applications.	125mm	1305090RV	£27.75
	155mm	1306090RV	£32.35
	180mm	1307090RV	£36.98
	200mm	1308090RV	£41.60
	100 – 125mm	1305097RV	£32.35
	125 – 155mm	1306097RV	£36.98
	155 – 180mm	1307097RV	£41.60
	180 – 200mm	1308097RV	£46.24
 <b>Nose Cone (screw / twist on for tecnoflex)</b> Lightweight nose cone used to help pull the liner down the stack.	125mm	9505105S	£26.41
	155mm	9506105S	£26.41
	180mm	9507105S	£26.41
	200mm	9508105S	£26.41
 <b>Pot Hanger (screw / twist on for tecnoflex)</b> Screw fit fastening on to top of liner used to hang liner from the chimney pot (up to 15m)	125mm	9505041RV	£68.07
	155mm	9506041RV	£70.04
 <b>Pot Hanger and Terminal (screw / twist on for tecnoflex)</b> Screw fit fastening on to top of liner used to hang liner from the chimney pot with rain cap terminal attached. (up to 15m)	125mm	9505040RV	£121.91
	155mm	9506040RV	£130.03
 <b>Joiner (screw / twist on for tecnoflex)</b> Used to join two pieces of tecnoflex liner together.	125mm	9505100S	£50.84
	155mm	9506100S	£55.47
	180mm	9507100S	£60.09
	200mm	9508100S	£64.73

## ? Did you know?

316 Tecnoflex now comes with a lifetime guarantee.

#designedtobebetter

Screw Fit Illustration

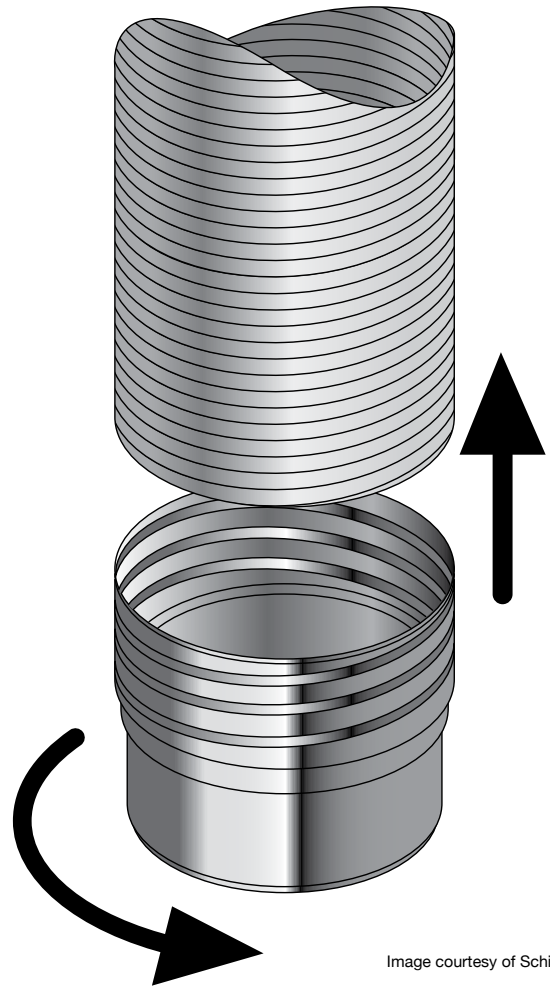





















Image courtesy of Schiedel





Product Description	Diameter	Part No.	Price
<b>Specflex</b>			
 <b>316 Specflex (per metre)</b> Twin skinned 316L grade stainless steel flexible liner 10 year warranty	125mm	9605111	£104.97
	155mm	9606111	£147.01
	180mm	9607111	£176.41
	200mm	9608111	£199.93
 <b>904 Specflex (per metre)</b> Twin skinned 904L grade stainless steel flexible liner 25 year warranty	125mm	9105904	£158.81
	155mm	9106904	£191.88
	180mm	9107904	£218.13
	200mm	9108904	£250.18

From 1st Jan 2018

+ 6%

Product Description	Diameter	Part No.	Price
<b>Universal Fittings</b>			
 <b>Clamping Support Plate</b> 375mm <sup>2</sup> top plate with clamp attached used to hang liner on top of brick stack	125mm	9505112	£56.42
	155mm	9506112	£56.42
	180mm	9507112	£56.42
	200mm	9508112	£56.42
 <b>Top Plate</b> 375mm <sup>2</sup> top plate used with top clamp used to support liner on top of brick stack	100mm	9504113	£44.38
	125mm	9505113	£42.67
	155mm	9506113	£42.67
	180mm	9507113	£42.67
	200mm	9508113	£42.67
 <b>Top Clamp</b> Used with top plate to support liner on top of brick stack	100mm	9504114	£26.11
	125mm	9505114	£27.20
	155mm	9506114	£27.20
	180mm	9507114	£39.45
 <b>Top Insert</b> Used to protect the top of the liner 194mm high	100mm	9504101	£26.19
	125mm	9505101	£26.19
	155mm	9506101	£28.56
	180mm	9507101	£33.36
 <b>Top Insert 1000mm Long</b> Used to protect the top of the liner with longer length	125mm	9505101E	£94.36
	155mm	9506101E	£104.89
	180mm	9507101E	£122.54
	200mm	9508101E	£123.35
 <b>Adaptor to Flex (1mm Thick)</b> Pushfit adaptor from connecting flue to flexible liner	100mm	1304090	£43.66
	125mm	1305090	£43.66
	155mm	1306090	£43.66
	180mm	1307090	£56.66
	200mm	1308090	£58.35
 <b>Adaptor to Flex (Extended)</b> Pushfit adaptor from connecting flue to flexible liner with 195mm tail	125mm	1305090T	£59.58
	155mm	1306090T	£65.56
	180mm	1307090T	£83.45
	200mm	1308090T	£92.40
 <b>Increasing Adaptor to Flex</b> Pushfit adaptor from connecting flue to flexible liner allowing an increase in diameter	100 – 125mm	1305097	£65.66
	100 – 150mm	1306096	£91.21
	125 – 155mm	1306097	£65.66
	155 – 180mm	1307097	£77.24
	180 – 200mm	1308097	£77.24
 <b>Register Plate Adaptor to Flex</b> 300mm <sup>2</sup> Plate with pushfit adaptor	125mm	1305065	£98.20
	155mm	1306065	£103.54
	180mm	1307065	£119.94
	200mm	1308065	£128.38

Product Description	Diameter	Part No.	Price
 <b>Increasing Register Plate Adaptor to Flex (300mm SQ Plate)</b> 300mm <sup>2</sup> plate with pushfit adaptor allowing an increase in diameter	100 – 125mm	1305066	£98.20
	125 – 155mm	1306066	£103.54
	155 – 180mm	1307066	£119.94
	180 – 200mm	1308066	£128.38
 <b>Register Plate Slip Adaptor</b> 300mm <sup>2</sup> plate with pushfit adaptor. Underside allows connecting pipe to slip into the adaptor for a neat finish.	125mm	1305063	£90.07
	155mm	1306063	£90.07
 <b>Bottom Support Bracket</b> Used to fasten the liner to the wall of the masonry chimney to prevent lateral movement	125mm	9505028	£38.78
	155mm	9506028	£40.91
	180mm	9507028	£43.06
	200mm	9508028	£43.06
 <b>Rain Cap (Top Insert Required)</b> Used to help prevent excess water entering the chimney	125mm	9505074	£60.95
	155mm	9506074	£69.42
	180mm	9507074	£75.12
	200mm	9508074	£81.55
 <b>Pot Hanger</b> Easyfit fastening to top of liner used to hang liner from the chimney pot	100mm	9504041	£58.70
	125mm	9505041	£59.32
	155mm	9506041	£64.29
	180mm	9507041	£66.82
 <b>Pot Hanging Cowl – S/S Terracotta</b> All in one liner hanger from pot with rain & birdguard attached	125mm	3505001	£98.50
	155mm	3506001	£98.50
	180mm	3507001	£98.50
 <b>Pot Hanging Cowl – S/S Buff</b> All in one liner hanger from pot with rain & birdguard attached	125mm	3505001B	£98.50
	155mm	3506001B	£98.50
 <b>S/S Nose Cone (Heavy Duty)</b> 316 1mm stainless steel heavy duty nose cone used to help pull liner down chimney stack	125mm	9505105	£97.63
	155mm	9506105	£111.97
	180mm	9507105	£116.77
	200mm	9508105	£121.51

Product Description	Diameter	Part No.	Price
 <b>Ali Nose Cone and Cord (Lightweight)</b> Lightweight nose cone used to help pull the liner down the stack	100mm	9504105F	<b>£9.03</b>
	125mm	9505105F	<b>£11.29</b>
	155mm	9506105F	<b>£11.29</b>
	180mm	9507105F	<b>£11.29</b>
	200mm	9508105F	<b>£11.29</b>
 <b>Joiner (Flex to Flex)</b> Used to join two pieces of flexible liner together.	100mm	9504100	<b>£50.34</b>
	125mm	9505100	<b>£50.91</b>
	155mm	9506100	<b>£55.59</b>
	180mm	9507100	<b>£59.46</b>
	200mm	9508100	<b>£61.74</b>
 <b>Sump Adaptor – 280mm Dish</b> Used to attach stove connecting pipe to the underside of a masonry stack	125mm	1305087	<b>£79.44</b>
	155mm	1306087	<b>£85.40</b>
	180mm	1307087	<b>£91.40</b>
	200mm	1308087	<b>£98.59</b>
 <b>Sump Adaptor – 330mm Dish</b> Used to attach stove connecting pipe to the underside of a masonry stack	125mm	1305050	<b>£79.44</b>
	155mm	1306050	<b>£85.40</b>
	180mm	1307050	<b>£91.40</b>
	200mm	1308050	<b>£98.59</b>
 <b>Adaptor to Clay Flue Liner</b> Used to connect stove connecting pipe to clayliner	125 – 175mm	1305088	<b>£132.43</b>
	155 – 175mm	1306088	<b>£132.43</b>
	175mm	1307088	<b>£132.43</b>
	125 – 200mm	13050888	<b>£132.43</b>
	155 – 200mm	13060888	<b>£132.43</b>
	175 – 200mm	13070888	<b>£132.43</b>
	200mm	1308088	<b>£132.43</b>
	125 – 225mm	1305089	<b>£132.43</b>
	155 – 225mm	1306089	<b>£132.43</b>
	175 – 225mm	1307089	<b>£132.43</b>
	200 – 225mm	1308089	<b>£132.43</b>