

# Oil

Vitreous Enamel Gloss Black	<b>3.2</b>
Flexible Liner & Fittings	<b>3.5</b>
ICID Plus – Twin Wall Chimney System	<b>3.6</b>
ICID Plus Matt Black – Twin Wall Chimney System	<b>3.13</b>

# Vitreous Gloss Black

Suitable for: Woodburning, Solid Fuel, Gas & Oil













Condensing	Locking Bands Req.	Locking Bands Inc.	Distance to Combustibles	Material	Insulation Thickness	Manufacturer	Manufactured in the UK	Warranty
X	X	X	3 x Diameter	1.2mm Mild Steel 2 coats of enamel	N/A	Pennine	✓	1 Year

Product Description	Diameter	Part No.	Price	
<b>Adaptors</b>				
	<b>Economy Adaptor To Flex Liner</b>	100mm	2304063	£63.90
	Enables connection to flexible liner	125mm	2305063	£69.36
		150mm	2306063	£73.39
	Liner pushes in to socket	175mm	2307063	£94.73
		200mm	2308063	£82.74
	<b>Increasing Adaptor To Flex Liner</b>	100 – 125mm	2305096	£69.89
	Enables connection to flexible liner with an increase in diameter	125 – 150mm	2306096	£75.18
	<b>Cut Length Adaptor</b>	100mm	2304097	£60.95
	Enables connection of cut vitreous lengths.	125mm	2305097	£60.95
	Replaces socket on the cut end	150mm	2306097	£60.95
		175mm	2307097	£68.56
		200mm	2308097	£71.14
	<b>Increasing Spun Adaptor</b>	100 – 125mm	2304081	£58.81
	Enables an increase in diameter of the vitreous length	125 – 150mm	2305081	£59.76
		150 – 175mm	2306081	£63.79
		175 – 200mm	2307081	£78.10
	<b>Tapered Adaptor</b>	100 – 125mm	2304090	£73.20
	Enables smooth connection to flex liner	125 – 150mm	2305090	£74.44
	Increases diameter by one step over 300mm taper	150 – 175mm	2306090	£85.66
		175 – 200mm	2307090	£96.40
	<b>Double Socket Adaptor</b>	100mm	2304603	£57.91
	Enables female to female end connection in one length	125mm	2305603	£61.55
		150mm	2306603	£67.04
		200mm	2308603	£70.62
	<b>Double Spigot Adaptor</b>	100mm	2304604	£57.91
	Enables male to male end connection in one length	125mm	2305604	£61.55
		150mm	2306604	£67.04
		175mm	2307604	£68.84
		200mm	2308604	£70.62

Product Description	Diameter	Part No.	Price	
<b>Pipes</b>				
	<b>300mm Straight Pipe</b>	100mm	2304012	£54.07
	260mm installed length	125mm	2305012	£63.50
		150mm	2306012	£75.12
		175mm	2307012	£86.04
		200mm	2308012	£100.28
	<b>300mm Straight Pipe With Door</b>	100mm	2304015	£77.40
	Installed length 260mm with provision for inspection and cleaning	125mm	2305015	£86.89
		150mm	2306015	£98.39
		175mm	2307015	£109.38
		200mm	2308015	£123.60
	<b>600mm Straight Pipe</b>	100mm	2304005	£77.78
	Installed length 560mm	125mm	2305005	£78.95
		150mm	2306005	£89.76
		175mm	2307005	£104.17
		200mm	2308005	£119.41
	<b>600mm Straight Pipe With Door</b>	100mm	2304010	£107.93
	Installed length 560mm with provision for inspection and cleaning	125mm	2305010	£110.15
		150mm	2306010	£120.89
		175mm	2307010	£135.37
		200mm	2308010	£150.48
	<b>900mm Straight Pipe</b>	100mm	2304003	£104.08
	Installed length 860mm	125mm	2305003	£107.62
		150mm	2306003	£119.52
		175mm	2307003	£137.00
		200mm	2308003	£165.89
	<b>900mm Straight Pipe With Door</b>	100mm	2304004	£135.23
	Installed length 860mm with provision for inspection and cleaning	125mm	2305004	£138.80
		150mm	2306004	£150.59
		175mm	2307004	£185.03
		200mm	2308004	£197.04
	<b>1200mm Straight Pipe</b>	100mm	2304007	£135.14
	Installed length 1160mm	125mm	2305007	£142.51
		150mm	2306007	£157.51
		175mm	2307007	£172.69
		200mm	2308007	£213.13
	<b>1200mm Straight Pipe With Door</b>	100mm	2304014	£166.33
	Installed length 1160mm with provision for inspection and cleaning	125mm	2305014	£173.74
		150mm	2306014	£188.65
		175mm	2307014	£203.84
		200mm	2308014	£244.25

Product Description	Diameter	Part No.	Price
 <b>350 – 550mm Adj Pipe No Door</b> Adjustable pipe used to achieve specific flue lengths.	100mm	2304016	£108.06
	125mm	2305016	£126.91
	150mm	2306016	£150.30
	175mm	2307016	£172.19
	200mm	2308016	£200.56
 <b>600 – 900mm Adj Pipe With Door</b> Adjustable pipe used to achieve specific flue lengths Provision for inspection and cleaning	100mm	2304017	£132.31
	125mm	2305017	£149.95
	150mm	2306017	£167.50
 <b>600 – 1020mm Adj Pipe No Door</b> Adjustable pipe used to achieve specific flue lengths	150mm	2306013	£131.06
 <b>900 – 1450mm Adj Pipe With Door</b> Adjustable pipe used to achieve specific flue lengths Provision for inspection and cleaning	150mm	2306018	£263.60
 <b>900 – 1600mm Adj Pipe No Door</b> Adjustable pipe used to achieve specific flue lengths	150mm	2306018N	£247.45
 <b>Damper Unit</b> Reduces the adverse affects of a strong flue up draught	100mm	2304008	£101.18
	125mm	2305008	£107.15
	150mm	2306008	£118.00
	75mm installed length	175mm	2307008
<b>Elbows / Tees</b>			
 <b>165° / 15° Mitred Bend</b> Enables angling of flue run if necessary	100mm	2304025	£89.29
	125mm	2305025	£100.67
	150mm	2306025	£116.06
 <b>165° / 15° Mitred Bend With Door</b> Enables angling of flue run if necessary Provision for inspection and cleaning	100mm	2304027	£121.48
	125mm	2305027	£134.27
	150mm	2306027	£145.30
 <b>150° / 30° Mitred Bend</b> Enables angling of flue run if necessary	100mm	2304024	£89.29
	125mm	2305024	£100.67
	150mm	2306024	£116.06
	175mm	2307024	£137.00
	200mm	2308024	£167.08
 <b>150° / 30° Mitred Bend With Door</b> Enables angling of flue run if necessary Provision for inspection and cleaning	100mm	2304026	£121.48
	125mm	2305026	£134.27
	150mm	2306026	£145.30
	175mm	2307026	£165.72
	200mm	2308026	£196.12

Product Description	Diameter	Part No.	Price
 <b>135° / 45° Swept Bend</b> Enables angling of flue run if necessary	100mm	2304022	£89.29
	125mm	2305022	£100.67
	150mm	2306022	£116.06
	175mm	2307022	£137.00
	200mm	2308022	£167.08
 <b>135° / 45° Swept Bend With Door</b> Enables angling of flue run if necessary Provision for inspection and cleaning	100mm	2304020	£121.48
	125mm	2305020	£134.27
	150mm	2306020	£145.30
	175mm	2307020	£165.72
	200mm	2308020	£196.12
 <b>90° Swept Bend</b> Enables angling of flue run if necessary	100mm	2304019	£106.86
	125mm	2305019	£117.70
	150mm	2306019	£128.76
	175mm	2307019	£150.31
	200mm	2308019	£176.50
 <b>90° Swept Bend With Door</b> Enables angling of flue run if necessary Provision for inspection and cleaning	100mm	2304021	£142.08
	125mm	2305021	£153.83
	150mm	2306021	£165.50
	175mm	2307021	£187.28
	200mm	2308021	£211.37
 <b>Offset Section</b> Enables connection of chimney to appliance without joints 100mm offset, 520mm installed length	100mm	2304028	£184.06
	125mm	2305028	£202.18
	150mm	2306028	£208.48
 <b>90° Tee Without Cap (Type D)</b> Enables connection at rear of appliance with horizontal connection (spigot branch)	100mm	2304043	£138.56
	125mm	2305043	£147.58
	150mm	2306043	£155.54
	175mm	2307043	£165.90
	200mm	2308043	£252.14
 <b>90° Stabiliser Tee (Type B)</b> Standard 90° tee with socket branch	100mm	2304042	£138.56
	125mm	2305042	£147.58
	150mm	2306042	£155.51
	175mm	2307042	£165.90
	200mm	2308042	£252.14
 <b>135° Tee Without Cap</b> Angled tee with branch spigot	100mm	2304044	£152.48
	125mm	2305044	£162.29
	150mm	2306044	£171.06
	175mm	2307044	£246.97
 <b>Tee Cap (Stainless Steel)</b> Enables closure of tee piece at bottom of system Enables cleaning and inspection	100mm	2504053	£37.43
	125mm	2505053	£37.43
	150mm	2506053	£39.53
	175mm	2507053	£44.33
	200mm	2508053	£53.05

Product Description	Diameter	Part No.	Price
<b>Accessories</b>			
 <b>Painted Wall Band</b> Enables lateral support of vitreous pipe Can be cut to requirements	150mm	2306067	<b>£50.14</b>
 <b>Enamel Pole Type Wall Band</b> Enables lateral support of vitreous pipe Can be cut to requirements	100mm	2304088	<b>£67.55</b>
	125mm	2305088	<b>£67.55</b>
	150mm	2306088	<b>£67.55</b>
 <b>Ceiling Trim Ring</b> Fits around pipe as it enters ceiling or wall 1 piece	100mm	2304085	<b>£35.00</b>
	125mm	2305085	<b>£35.00</b>
	150mm	2306085	<b>£35.00</b>
	175mm	2307085	<b>£45.72</b>
 <b>45° Angled Trim Ring</b> Fits around pipe as it enters ceiling or wall at an angle 2 piece	100mm	2304085A	<b>£76.31</b>
	125mm	2305085A	<b>£76.48</b>
	150mm	2306085A	<b>£86.72</b>
 <b>Flush Trim Ring</b> Fits around pipe as it enters ceiling or wall, with upstand on one edge 2 piece	100mm	2304085F	<b>£73.92</b>
	125mm	2305085F	<b>£76.18</b>
 <b>Split Trim Ring</b> Fits around pipe as it enters ceiling or wall 2 piece	100mm	2304085S	<b>£77.82</b>
	125mm	2305085S	<b>£80.39</b>
	150mm	2306085S	<b>£80.39</b>
	175mm	2307085S	<b>£81.70</b>
 <b>1D5 Gasket</b> MK1 Door Gasket for 125mm swept bend	100mm	2308085S	<b>£82.74</b>
	200mm	2308085S	<b>£82.74</b>
 <b>1D6 Gasket</b> MK1 Door Gasket for 150mm swept bend	125mm	2500104	<b>£7.30</b>
 <b>1D6 Gasket</b> MK1 Door Gasket for 150mm swept bend	150mm	2500105	<b>£7.30</b>
 <b>MK2 Gasket</b> 100 – 150mm Oval Door Gasket		2500107	<b>£7.58</b>
 <b>MK3 Gasket</b> 130 – 190mm Oval Door Gasket		2500108	<b>£7.25</b>
 <b>MK4 Gasket</b> 200 – 240mm Square Door Gasket		2500109	<b>£7.58</b>
 <b>MK2 Door – Stainless Steel</b> Replacement Oval Door for Mitred Bends 100 – 150mm & all 100mm pipes		2300MK2	<b>£9.31</b>

Product Description	Diameter	Part No.	Price
 <b>MK3 Door – Stainless Steel</b> Replacement Door for 125 – 150mm 300mm pipes & 175 – 200mm 300mm pipes & bends		2300MK3	<b>£11.09</b>
 <b>MK4 Door – Stainless Steel</b> Replacement Door for 125 – 200mm, 500mm – 1200mm pipes		2300MK4	<b>£12.98</b>
 <b>1D5 Door – Gloss Black</b> MK1 Replacement Swept Bend Door for 125mm	125mm	2305MK1	<b>£15.49</b>
 <b>1D6 Door – Gloss Black</b> MK1 Replacement Swept Bend Door for 150mm	150mm	2306MK1	<b>£21.79</b>
 <b>MK2 Door – Gloss Black</b> Replacement Oval Door for Mitred Bends 100 – 150mm & all 100mm pipes	100mm	2304MK2	<b>£21.98</b>
	125mm	2305MK2	<b>£21.98</b>
	150mm	2306MK2	<b>£21.98</b>
 <b>MK3 Door – Gloss Black</b> Replacement Door for 125 – 150mm 300mm pipes & 175 – 200mm 300mm pipes & bends	125mm	2305MK3	<b>£21.98</b>
	150mm	2306MK3	<b>£21.98</b>
	175mm	2307MK3	<b>£21.98</b>
	200mm	2308MK3	<b>£20.95</b>
 <b>MK4 Door – Gloss Black</b> Replacement Door for 125 – 200mm, 500mm – 1200mm pipes	125mm	2305MK4	<b>£27.04</b>
	150mm	2306MK4	<b>£27.04</b>
	175mm	2307MK4	<b>£27.04</b>
	200mm	2308MK4	<b>£25.69</b>
 <b>8mm Universal Test Point</b> Can be retro fitted to allow draught reading to be taken		34UTP	<b>£12.14</b>



## Do you need?



Fire Cement, Glass Fibre Cord or Sealant Adhesive











See the Installation Essentials section on page 5.13



# Flex & Fittings

Product Description	Diameter	Part No.	Price
<b>Flexible Liner</b>			
 <b>Gas &amp; 28 Sec. Oil Liner</b> Single wall stainless steel flexible flue liner designed for atmospheric gas and kerosene appliances where the flue gas temperature does not exceed 260°C. T300 N1 W V2 L50010 O	100mm	9904111	£38.94
	125mm	9905111	£38.94
	150mm	9906111	£59.48
	180mm	9907111	£73.80
	200mm	9908111	£82.03

<b>Fittings</b>			
 <b>Plate &amp; Clamp (Combined)</b> Lightweight combined plate clamp seal used to support the liner at the top of the stack.	100mm	9904112	£7.33
	125mm	9905112	£7.33
	150mm	9906112	£10.97
	180mm	9907112	£58.89
 <b>Cone Cap for Oil (Meshed)</b> Oil Terminal suitable to fit on flexible liner Fix with self tapping screws	100mm	9904074	£92.90
	125mm	9905074	£87.50
	150mm	9906074	£102.50
	180mm	9907074	£101.30
 <b>Oil Term Type B Terminal (For Chimneys With Pots)</b> Oil Terminal with spun base and strap to support liner from an existing pot	100mm	9904074B	£140.60
	125mm	9905074B	£140.95
	150mm	9906074B	£151.05
 <b>Adaptor to Flex (1mm Thick)</b> Pushfit adaptor from connecting flue to flexible liner	100mm	1304090	£63.68
	125mm	1305090	£63.68
	155mm	1306090	£63.68
	180mm	1307090	£82.62
 <b>Adaptor to Flex (Extended)</b> Pushfit adaptor from connecting flue to flexible liner with 195mm tail	200mm	1308090	£85.10
	125mm	1305090T	£86.88
	155mm	1306090T	£95.60
	180mm	1307090T	£121.70
 <b>Increasing Adaptor to Flex</b> Pushfit adaptor from connecting flue to flexible liner allowing an increase in diameter	200mm	1308090T	£134.75
	100 – 125mm	1305097	£95.76
	100 – 155mm	1306096	£133.01
	125 – 155mm	1306097	£95.76
	155 – 180mm	1307097	£112.64
 <b>Ali Nose Cone and Cord (Lightweight)</b> Lightweight nose cone used to help pull the liner down the stack	180 – 200mm	1308097	£112.64
	100mm	9504105F	£15.46
	125mm	9505105F	£19.33
	155mm	9506105F	£19.33
	180mm	9507105F	£19.33
200mm	9508105F	£19.33	

Product Description	Diameter	Part No.	Price
<b>Flexible Liner Packs (Includes Plate / Clamp and Terminal)</b>			
 <b>5 Metre Length Pack</b> Triplelock Gas & Oil Liner length complete with Clamp Plate Seal & Cone Cap	100mm	9904005A	£249.69
	125mm	9905005A	£244.12
	150mm	9906005A	£365.80
 <b>6 Metre Length Pack</b> Triplelock Gas & Oil Liner length complete with Clamp Plate Seal & Cone Cap	100mm	9904006A	£288.66
	125mm	9905006A	£292.86
	150mm	9906006A	£425.24
 <b>7 Metre Length Pack</b> Triplelock Gas & Oil Liner length complete with Clamp Plate Seal & Cone Cap	100mm	9904007A	£327.64
	125mm	9905007A	£331.80
	150mm	9906007A	£484.70
 <b>8 Metre Length Pack</b> Triplelock Gas & Oil Liner length complete with Clamp Plate Seal & Cone Cap	100mm	9904008A	£366.59
	125mm	9905008A	£370.76
	150mm	9906008A	£544.16
 <b>9 Metre Length Pack</b> Triplelock Gas & Oil Liner length complete with Clamp Plate Seal & Cone Cap	100mm	9904009A	£405.54
	125mm	9905009A	£409.75
	150mm	9906009A	£603.64
 <b>10 Metre Length Pack</b> Triplelock Gas & Oil Liner length complete with Clamp Plate Seal & Cone Cap	100mm	9904010A	£444.50
	125mm	9905010A	£448.68
	150mm	9906010A	£663.10
 <b>11 Metre Length Pack</b> Triplelock Gas & Oil Liner length complete with Clamp Plate Seal & Cone Cap	100mm	9904011A	£483.45
	125mm	9905011A	£487.65
	150mm	9906011A	£722.55
 <b>12 Metre Length Pack</b> Triplelock Gas & Oil Liner length complete with Clamp Plate Seal & Cone Cap	100mm	9904012A	£522.45
	125mm	9905012A	£526.61
	150mm	9906012A	£782.01
 <b>13 Metre Length Pack</b> Triplelock Gas & Oil Liner length complete with Clamp Plate Seal & Cone Cap	100mm	9904013A	£561.38
	125mm	9905013A	£565.56
 <b>14 Metre Length Pack</b> Triplelock Gas & Oil Liner length complete with Clamp Plate Seal & Cone Cap	100mm	9904014A	£600.32
	125mm	9905014A	£604.51
 <b>15 Metre Length Pack</b> Triplelock Gas & Oil Liner length complete with Clamp Plate Seal & Cone Cap	100mm	9904015A	£639.31
	125mm	9905015A	£643.49

# ICID Plus











**Suitable for:** Woodburning, Solid Fuel, Gas & Oil

**Designation Number:** T200 P1 W V2 L50050 000 (wet systems), T450 N1 D V3 L50050 G50 (in free air / non combustible shaft), T450 N1 D V3 L50050 G60 (in combustible shaft)

Condensing	Locking Bands Req.	Locking Bands Inc.	Distance to Combustibles	Material	Insulation Thickness	Manufacturer	Manufactured in the UK	Warranty
✓ (add seals)	✓	✓	60mm	316 / 304 Stainless Steel	25mm	Schiedel	✓	20 years or lifetime of appliance

Product Description	Diameter	Part No.	Price
<b>Starting Components</b>			
 36.8504 pt	125mm	0905093	<b>£80.48</b>
	150mm	0906093	<b>£85.49</b>
	180mm	0907093	<b>£105.62</b>
	200mm	0908093	<b>£125.73</b>
 <b>SW-DW Connector (Open Uninsulated)</b> For connecting to stove pipe. Must be sealed for a gas tight joint	125mm	0905094	<b>£45.25</b>
	150mm	0906094	<b>£50.30</b>
	180mm	0907094	<b>£65.38</b>
	200mm	0908094	<b>£70.40</b>
 <b>Insulated Appliance Connector</b> For connecting directly on to appliance	125mm	0905101	<b>£128.59</b>
	150mm	0906101	<b>£132.59</b>
	180mm	0907101	<b>£155.31</b>
	200mm	0908101	<b>£168.11</b>
 <b>Adaptor From B/K Vent</b> Adaptor to connect from B/K Vent to twinwall	125mm	0905095	<b>£178.32</b>
	150mm	0906095	<b>£187.25</b>
 <b>Increasing S/W – ICID Adaptor With Case (Insulated)</b> Increasing adaptor from single wall / appliance with step covered by insulated case to provide a more appealing aesthetic	125mm	0905098	<b>£90.52</b>
	150mm	0906098	<b>£100.57</b>
	180mm	0907098	<b>£120.70</b>
	200mm	0908098	<b>£134.06</b>
 <b>Increasing S/W – ICID Adaptor Closed (Uninsulated For Use On Rear Outlets)</b> Increasing adaptor from single wall / appliance. Uninsulated and increasing step shown – best for rear outlet installations	125mm	0905097	<b>£100.57</b>
	150mm	0906097	<b>£110.65</b>
 <b>SW-DW Starter Pipe 473mm (Short)</b> Gives a tapered increase from single to twinwall – must only be used on stove connection pipe, not directly onto appliance	125mm	0905102	<b>£170.97</b>
	150mm	0906102	<b>£181.06</b>

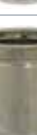
Product Description	Diameter	Part No.	Price
 <b>SW-DW Increasing Starter Pipe 1018mm (Long)</b> Gives a tapered increase from single to twinwall – must only be used on stove connection pipe, not directly onto appliance	125 – 150mm	0906104	<b>£251.46</b>
 <b>SW-DW Starter Pipe 973mm (Long)</b> Gives a tapered increase from single to twinwall – must only be used on stove connection pipe, not directly onto appliance	125mm	0905202	<b>£216.26</b>
	150mm	0906202	<b>£226.31</b>
 <b>Prima Smooth to ICID Starter Pipe 1200mm</b> Tapered adaptor designed exclusively for Prima Smooth to slide inside the spigot end of the adaptor, giving a smooth transition to twinwall	125mm	0905201	<b>£316.25</b>
	150mm	0906201	<b>£339.65</b>
 <b>Anchor Plate (Plain)</b> For use on top of a firechest or the top of an existing cut off stack.	125mm	0905089	<b>£170.97</b>
	150mm	0906089	<b>£170.97</b>
	180mm	0907089	<b>£201.17</b>
	200mm	0908089	<b>£231.34</b>
 <b>Anchor Plate (Screw Type)</b> For use on top of a firechest or top of an existing cut off stack. For use with Tecnoflex Liner	125mm	0905089S	<b>£198.51</b>
	150mm	0906089S	<b>£198.51</b>
	180mm	0907089S	<b>£229.87</b>
	200mm	0908089S	<b>£261.17</b>
 <b>Prima Smooth to ICID Starter Adaptor (Slip In Adaptor)</b> Tapered adaptor designed exclusively for Prima Smooth to slide inside the spigot end of the adaptor, giving a smooth transition to twinwall	125mm	0905099	<b>£149.90</b>
	150mm	0906099	<b>£159.59</b>
	180mm	0907099	<b>£168.88</b>
	200mm	0908099	<b>£215.77</b>









Product Description	Diameter	Part No.	Price
 <b>Increasing Prima Smooth Starter Adaptor (Slip In Adaptor)</b> Tapered adaptor designed exclusively for Prima Smooth to slide inside the spigot end of the adaptor, giving a smooth transition to twinwall	125 –	0906100	<b>£208.81</b>
	150mm		
 <b>Adjustable Starter Section 1035mm</b> Designed for ease of use when installing and disconnecting a stove for inspection	125mm	0905014	<b>£282.04</b>
	150mm	0906014	<b>£307.90</b>
 <b>Adjustable Starter Section 890mm</b> Designed for ease of use when installing and disconnecting a stove for inspection	180mm	0907014	<b>£370.26</b>
	200mm	0908014	<b>£392.68</b>
 <b>Adjustable Starter Section 600mm</b> Designed for ease of use when installing and disconnecting a stove for inspection	125mm	0905999	<b>£213.95</b>
	150mm	0906999	<b>£224.54</b>
	180mm	0907999	<b>£285.42</b>
	200mm	0908999	<b>£303.45</b>
<b>Lengths</b>			
 <b>1460mm Straight Length</b> Standard straight length of flue	125mm	0905001	<b>£308.88</b>
	150mm	0906001	<b>£326.79</b>
 <b>960mm Straight Length</b> Standard straight length of flue	125mm	0905002	<b>£166.97</b>
	150mm	0906002	<b>£189.10</b>
	180mm	0907002	<b>£241.40</b>
	200mm	0908002	<b>£251.46</b>
 <b>750mm Straight Length</b> Standard straight length of flue	125mm	0905004	<b>£150.88</b>
	150mm	0906004	<b>£165.97</b>
	180mm	0907004	<b>£201.17</b>
	200mm	0908004	<b>£221.28</b>
 <b>460mm Straight Length</b> Standard straight length of flue	125mm	0905005	<b>£126.71</b>
	150mm	0906005	<b>£138.80</b>
	180mm	0907005	<b>£160.92</b>
	200mm	0908005	<b>£165.97</b>
 <b>293mm Straight Length</b> Standard straight length of flue	125mm	0905012	<b>£91.53</b>
	150mm	0906012	<b>£98.58</b>
	180mm	0907012	<b>£125.73</b>
	200mm	0908012	<b>£130.75</b>
 <b>160mm Straight Length</b> Standard straight length of flue	125mm	0905006	<b>£81.47</b>
	150mm	0906006	<b>£88.52</b>
	180mm	0907006	<b>£100.57</b>
	200mm	0908006	<b>£105.62</b>
 <b>50 – 230mm Telescopic Length (1 Piece)</b> 1 Piece section used to add length to a standard length	125mm	0905015	<b>£146.85</b>
	150mm	0906015	<b>£150.88</b>

Product Description	Diameter	Part No.	Price
 <b>350 – 570mm Adjustable Length</b> 2 Piece adjustable sliding length	125mm	0905016	<b>£206.18</b>
	150mm	0906016	<b>£211.21</b>
	180mm	0907016	<b>£251.46</b>
	200mm	0908016	<b>£276.61</b>
 <b>215 – 310mm Adjustable Length</b> 2 Piece adjustable sliding length	125mm	0905018	<b>£186.08</b>
	150mm	0906018	<b>£191.11</b>
	180mm	0907018	<b>£226.31</b>
	200mm	0908018	<b>£251.46</b>
 <b>Inspection Pipe with Test Point (Condensing Only)</b> Installed as a standard length the inspection hatch offers facility for flue access & cleaning and a locking plug with a lip seal gasket. 302mm installed length	125mm	0905013C	<b>£359.58</b>
	150mm	0906013C	<b>£404.43</b>
 <b>Inspection Pipe with Test Point (Dry Applications Only)</b> Installed as a standard length the inspection hatch offers facility for flue access & cleaning and a locking plug with a lip seal gasket. 302mm installed length	125mm	0905013D	<b>£336.49</b>
	150mm	0906013D	<b>£387.78</b>
	180mm	0907013D	<b>£485.29</b>
	200mm	0908013D	<b>£454.15</b>
 <b>Stabiliser Section</b> Stabiliser Section which can be fitted to a tee branch	125mm	0905007	<b>£134.35</b>
	150mm	0906007	<b>£154.33</b>
	180mm	0907007	<b>£227.24</b>
	200mm	0908007	<b>£280.81</b>
 <b>Locking Band</b> Standard fastening for joints, included as standard on all ICID Plus parts with a female collar/socket joint	125mm	0905086	<b>£10.05</b>
	150mm	0906086	<b>£10.05</b>
	180mm	0907086	<b>£17.61</b>
	200mm	0908086	<b>£17.61</b>
<b>Elbows / Tees</b>			
 <b>15° Bend</b> Used for changing flue direction	125mm	0905025	<b>£136.79</b>
	150mm	0906025	<b>£158.92</b>
	180mm	0907025	<b>£181.06</b>
	200mm	0908025	<b>£186.08</b>
 <b>30° Bend</b> Used for changing flue direction	125mm	0905023	<b>£136.79</b>
	150mm	0906023	<b>£158.92</b>
	180mm	0907023	<b>£181.06</b>
	200mm	0908023	<b>£186.08</b>
 <b>45° Bend</b> Used for changing flue direction	125mm	0905022	<b>£136.79</b>
	150mm	0906022	<b>£158.92</b>
	180mm	0907022	<b>£181.06</b>
	200mm	0908022	<b>£186.08</b>
 <b>90° Bend</b> Used for changing flue direction	125mm	0905021	<b>£182.05</b>
	150mm	0906021	<b>£199.16</b>
	180mm	0907021	<b>£276.61</b>
	200mm	0908021	<b>£291.70</b>









Product Description	Diameter	Part No.	Price
 <b>90° Inspection Bend</b> Used for changing flue direction with facility for inspection via door	125mm	0905019	£257.50
	150mm	0906019	£284.65
	200mm	0908019	£376.40
 <b>90° Tee Including Cap (Cap Suitable For Tee Only)</b> Connect from connecting flue pipe to a chimney system or the branch may be used to locate a draft stabiliser, complete with drain cap for base	125mm	0905043	£383.20
	150mm	0906043	£418.42
	180mm	0907043	£452.62
	200mm	0908043	£477.75
 <b>135° Tee Including Cap (Cap Suitable For Tee Only)</b> Used in combination with a 45° bend from connecting flue pipe to a chimney system, complete with drain cap for base	125mm	0905044	£358.06
	150mm	0906044	£418.42
	180mm	0907044	£477.75
	200mm	0908044	£502.92
 <b>Tee Cap</b> Standard tee cap for tee – fits base of tee only	125mm	0905091	£50.30
	150mm	0906091	£50.30
	180mm	0907091	£60.35
	200mm	0908091	£70.40
 <b>Tee Cap &amp; Drain</b> Tee cap with drain off fitting – fits base of tee only	125mm	0905532	£60.35
	150mm	0906532	£60.35
	180mm	0907532	£70.40
	200mm	0908532	£80.48
 <b>Insulated Tee Cap (Fits Wall Support Top Plate)</b> Tee cap designed to fit onto tee or any ICID fitting	125mm	0905053	£148.36
	150mm	0906053	£157.16
 <b>Insulated Tee Cap &amp; Drain (Fits Wall Support Top Plate)</b> Tee cap designed to fit onto tee or any ICID fitting with added drain off fitting	125mm	0905533	£150.88
	150mm	0906533	£160.92
	180mm	0907533	£170.97
	200mm	0908533	£176.02
 <b>H&amp;S Stabiliser Adaptor</b> Used with 90° tee to connect H&S stabiliser.	125mm	0905099	£75.23
	150mm	0906099	£79.83
	200mm	0908099	£89.03







## Support / Penetration Components









 <b>135° Wall Sleeve (Combustible Wall)</b> Mitred sleeve used to protect the building where the flue passes through	125mm	0905050	£63.37
	150mm	0906050	£95.87
	180mm	0907050	£95.87
	200mm	0908050	£95.87
 <b>135° Wall Sleeve (Non-Combustible Wall)</b> Mitred sleeve used to protect the building where the flue passes through	125mm	0905051	£63.37
	150mm	0906051	£63.37
	180mm	0907051	£63.37
	200mm	0908051	£63.37







Product Description	Diameter	Part No.	Price
 <b>90° Wall Sleeve (Non Combustible Wall)</b> Sleeve used to protect the building where the flue passes through	125mm	0905052	£30.17
	150mm	0906052	£30.17
 <b>Top Plate</b> Supporting plate with Socket above and spigot below Can use with side plates or cantilever brackets for the weight bearing wall supports (includes locking band)	125mm	0905066	£130.75
	150mm	0906066	£140.82
	180mm	0907066	£176.02
	200mm	0908066	£181.06
 <b>Wall Support Side Plates</b> Triangular side plates for standard wall support offering 60mm distance away from wall	125mm	0905994	£115.67
	150mm	0906994	£125.73
	180mm	0907994	£130.75
	200mm	0908994	£140.82
 <b>Standard Wall Support 60mm Stand Off</b> Support plate with triangular side plates for standard wall support offering 60mm distance away from wall	125mm	0905998	£246.41
	150mm	0906998	£266.54
	180mm	0907998	£306.79
	200mm	0908998	£321.85
 <b>Adj Wall Support 100mm Stand Off (Type 325 Arms)</b> Support plate with 325mm cantilever arms allowing up to 100mm extension distance away from wall	125mm	0905325	£291.70
	150mm	0906325	£301.74
	180mm	0907325	£336.95
	200mm	0908325	£336.14
 <b>Adj Wall Support 100 – 250mm Stand Off (Type 475 Arms)</b> Support plate with 475mm cantilever brackets allowing up to 250mm extension distance away from wall	125mm	0905475	£306.79
	150mm	0906475	£316.84
	180mm	0907475	£351.51
	200mm	0908475	£357.06
 <b>Adj Wall Support 100 – 350mm Stand Off (Type 570 Arms)</b> Support plate with 570mm cantilever brackets allowing up to 350mm extension distance away from wall	125mm	0905570	£357.06
	150mm	0906570	£367.14
	180mm	0907570	£402.33
	200mm	0908570	£407.36
 <b>Retrofit Wall Support</b> Band with triangular side plates providing 60-200mm stand off	125mm	0905200	£143.12
	150mm	0906200	£145.02



Product Description	Diameter	Part No.	Price
 <b>Wall Band 60mm</b> Standard lateral support wall band (suitable for internal & external application)	125mm	0905088	<b>£31.28</b>
	150mm	0906088	<b>£31.28</b>
	180mm	0907088	<b>£35.21</b>
	200mm	0908088	<b>£40.24</b>
 <b>Adjustable Wall Band 60 – 300mm (Band &amp; Bracket)</b> 09**088 & 09**067 combined as an extension band and bracket kit	125mm	0905067	<b>£85.49</b>
	150mm	0906067	<b>£90.52</b>
	180mm	0907067	<b>£100.57</b>
	200mm	0908067	<b>£110.65</b>
 <b>Wall Band Extension 50 – 100mm</b> Back bracket allowing extension of flue when using 09**088	125mm	0905064	<b>£15.24</b>
	150mm	0906064	<b>£16.31</b>
 <b>Retrofit Wall Band 60mm</b> Can be used on their own or combined with extension brackets for further adjustment.	125mm	0905088RF	<b>£55.26</b>
	150mm	0906088RF	<b>£59.87</b>
	180mm	0907088RF	<b>£69.08</b>
	200mm	0908088RF	<b>£73.70</b>
 <b>Retrofit Wall Band Extension W1 – 130mm</b> Short brackets to offer up to 100mm extension away from wall for retrofit wall bands	One Size	0900001	<b>£42.77</b>
 <b>Retrofit Wall Band Extension L1 – 300mm</b> Extension arms to allow up to 250mm extension away from wall for retrofit wall bands	One Size	0900002	<b>£138.29</b>
 <b>Retrofit Wall Band Extension L2 – 450mm</b> Extension arms to allow up to 440mm extension away from wall for retrofit wall bands	One Size	0900003	<b>£150.88</b>
 <b>Guy Wire Bracket</b> Used to secure unsupported chimney sections above the roof level with wires or rigid stays	125mm	0905092	<b>£40.95</b>
	150mm	0906092	<b>£41.37</b>
	180mm	0907092	<b>£45.25</b>
	200mm	0908092	<b>£45.25</b>
 <b>Flue Enclosure Kit 2400mm (Mesh, Bands &amp; Fittings)</b> 2 x 1200mm long galvanised mesh enclosures with bands and fittings, designed to be used within a loft space to ensure distance & ventilation around chimney system	125mm	0905559	<b>370.48</b>
	150mm	0906559	<b>370.48</b>
	180mm	0907557	<b>£370.48</b>
	200mm	0908557	<b>£370.48</b>

Product Description	Diameter	Part No.	Price
 <b>Roof (Rafter) Support</b> Flue band with side gimble plates comes as a kit for fixing to the roof trusses, offering lateral support	125mm	0905029	<b>£101.94</b>
	150mm	0906029	<b>£106.79</b>
	180mm	0907029	<b>£111.62</b>
	200mm	0908029	<b>£121.30</b>
 <b>Ceiling / Joist Support Plate With 700mm Arms</b> Ventilated support plate for use where chimney systems passes through ceiling joists, complete with joist arms for support	125mm	0905033	<b>£165.85</b>
	150mm	0906033	<b>£165.70</b>
	180mm	0907033	<b>£193.06</b>
	200mm	0908033	<b>£193.33</b>
 <b>Extended / Structural Locking Band</b> Used where the flue is freestanding above the roof and height exceeds 1.5m above the last support or roof Can support up to 3m from last support	125mm	0905086E	<b>£33.99</b>
	150mm	0906086E	<b>£35.71</b>
	180mm	0907086E	<b>£40.49</b>
	200mm	0908086E	<b>£43.75</b>
 <b>Structural Locking Band For Bend</b> As the extended standard locking bands but thinner to allow fitting on bends where offset is used	125mm	0905086EB	<b>£15.09</b>
	150mm	0906086EB	<b>£15.09</b>
	180mm	0907086EB	<b>£20.10</b>
	200mm	0908086EB	<b>£20.10</b>
 <b>Ceiling / Joist Support Plate (Non-Combustible Floor)</b> Used where the chimney system passes through a non-combustible floor for weight bearing support	125mm	0905032	<b>£50.30</b>
	150mm	0906032	<b>£50.30</b>
	180mm	0907032	<b>£75.44</b>
	200mm	0908032	<b>£80.48</b>
 <b>Firestop Spacer Two Piece (Non-Combustible Floor)</b> Two piece plate for use where chimney system passes through a non combustible ceiling / floor.	125mm	0905082	<b>£15.09</b>
	150mm	0906082	<b>£15.09</b>
	180mm	0907082	<b>£25.15</b>
	200mm	0908082	<b>£35.21</b>
 <b>90° Trim Collar One Piece</b> To cover when chimney system passes through a wall Covers 100mm (125 & 150mm) or 75mm (180 & 200mm) around external diameter of the flue	125mm	0905111	<b>£51.25</b>
	150mm	0906111	<b>£52.14</b>
	180mm	0907105	<b>£61.61</b>
	200mm	0908105	<b>£71.17</b>



Product Description	Diameter	Part No.	Price
 <b>135° Trim Collar One Piece</b> To cover when chimney system passes through the wall at 135° Covers 100mm (125 & 150mm) or 75mm (180 & 200mm) around external diameter of the flue	125mm	0905113	£62.51
	150mm	0906113	£63.86
	180mm	0907106	£90.39
	200mm	0908106	£92.69
 <b>135° Trim Collar Two Piece</b> To cover when chimney system passes through the wall at 135° Covers 100mm (125 & 150mm) or 75mm (180 & 200mm) around external diameter of the flue	125mm	0905114	£53.91
	150mm	0906114	£58.98
	180mm	0907107	£80.37
	200mm	0908107	£85.05
 <b>135° Trim Collar Two Piece (White)</b> To cover when chimney system passes through the wall at 135° Covers 75mm around external diameter of flue	125mm	0905107W	£71.92
	150mm	0906107W	£78.96
	180mm	0907107W	103.57
	200mm	0908107W	£110.37
 <b>0 – 20° Trim Collar Two Piece</b> Elliptical collar allowing multiple angles between 0 – 20°	125mm	0905245	£62.85
	150mm	0906245	£62.85
	180mm	0907245	£77.36
	200mm	0908245	£87.04
 <b>20 – 35° Trim Collar Two Piece</b> Elliptical collar allowing multiple angles between 20 – 35°	125mm	0905246	£62.85
	150mm	0906246	£62.85
	180mm	0907246	£77.36
	200mm	0908246	£87.04
 <b>35 – 45° Trim Collar Two Piece</b> Elliptical collar allowing multiple angles between 35 – 45°	125mm	0905247	£62.85
	150mm	0906247	£62.85
	180mm	0907247	£77.36
	200mm	0908247	£87.04
 <b>Ventilated Firestop Two Piece Rectangular (Combustible Floor)</b> To be used where the chimney passes through a combustible floor or ceiling	125mm	0905087	£65.38
	150mm	0906087	£65.38
	180mm	0907087	£85.49
	200mm	0908087	£90.52
 <b>Ventilated Firestop Support Plate 1 Piece (Combustible Floor)</b> To be used where the chimney passes through a combustible floor or ceiling	125mm	0905028	£117.55
	150mm	0906028	£123.00
	180mm	0907028	£129.32
	200mm	0908028	£143.69

Product Description	Diameter	Part No.	Price
 <b>Ventilated Firestop Round One Piece Steel (Combustible Floor)</b> Circular firestop to be used where chimney passes through a combustible floor or ceiling	125mm	0905083S	£65.38
	150mm	0906083S	£70.40
	180mm	0907083S	£80.48
	200mm	0908083S	£90.52
 <b>Ventilated Firestop Round One Piece White (Combustible Floor)</b> Circular firestop to be used where chimney passes through a combustible floor or ceiling	125mm	0905083W	£89.38
	150mm	0906083W	£89.38
	180mm	0907083W	£99.89
	200mm	0908083W	£110.42
 <b>Ventilated Firestop Round Two Piece Steel (Combustible Floor)</b> Circular firestop to be used where chimney passes through a combustible floor or ceiling	125mm	0905084S	£75.44
	150mm	0906084S	£80.48
	180mm	0907084S	£90.52
	200mm	0908084S	£100.57
 <b>Ventilated Firestop Round Two Piece White (Combustible Floor)</b> Circular firestop to be used where chimney passes through a combustible floor or ceiling	125mm	0905084W	£89.38
	150mm	0906084W	£94.63
	180mm	0907084W	£110.42
	200mm	0908084W	£115.68
 <b>Bungalow Circular Firestop One Piece Steel (Unvented)</b> Used for when chimney passes through a combustible ceiling in a bungalow into an open roof space	125mm	0905183S	£31.50
	150mm	0906183S	£32.47
	180mm	0907183S	£37.38
	200mm	0908183S	£38.80
 <b>Bungalow Circular Firestop One Piece White (Unvented)</b> Used for when chimney passes through a combustible ceiling in a bungalow into an open roof space	125mm	0905183W	£55.99
	150mm	0906183W	£59.98
	180mm	0907183W	£68.62
	200mm	0908183W	£73.60
 <b>Bungalow Circular Firestop Two Piece Steel (Unvented)</b> Used for when chimney passes through a combustible ceiling in a bungalow into an open roof space	150mm	0906184G	£77.96

Product Description	Diameter	Part No.	Price
 <b>Bungalow Circular Firestop Two Piece White (Unvented)</b> Used for when chimney passes through a combustible ceiling in a bungalow into an open roof space	150mm	0906184W	<b>£81.50</b>
 <b>Magnetic Cover Ring White</b> Optional decorative addition to ventilated firestop plate	125mm	0905110W	<b>£62.59</b>
	150mm	0906110W	<b>£62.59</b>
	180mm	0907110W	<b>£72.22</b>
	200mm	0908110W	<b>£72.22</b>

#### Terminals / Flashings

 <b>Rain Cap With Mesh</b> Rain Cap terminal with 25mm anti-bird mesh, terminates flue and offers rain protection	125mm	0905076	<b>£110.65</b>
	150mm	0906076	<b>£115.67</b>
	180mm	0907076	<b>£125.73</b>
	200mm	0908076	<b>£130.75</b>
 <b>Insulated Tapered Terminal</b> Open tapered terminal, terminates chimney system	125mm	0905073	<b>£160.92</b>
	150mm	0906073	<b>£176.02</b>
	180mm	0907073	<b>£181.06</b>
	200mm	0908073	<b>£186.08</b>
 <b>Adaptor To Flex</b> Twinwall chimney system to flexible liner adaptor	125mm	0905090	<b>£81.47</b>
	150mm	0906090	<b>£83.49</b>
	180mm	0907090	<b>£90.52</b>
	200mm	0908090	<b>£100.57</b>
 <b>Adaptor To Prima Plus From ICID</b> Twinwall to Prima Plus adaptor	125mm	0905063	<b>£81.47</b>
	150mm	0906063	<b>£83.49</b>
	180mm	0907063	<b>£95.55</b>
	200mm	0908063	<b>£105.62</b>
 <b>Top Adaptor for Kevington</b> Allows connection to prefabricated Kevington chimney	125mm	0905078	<b>£97.01</b>
	150mm	0906078	<b>£97.57</b>
	180mm	0907078	<b>£114.17</b>
	200mm	0908078	<b>£117.68</b>
 <b>Flat Flashing (Including Storm Collar)</b> Aluminium flat roof flashing including storm collar	125mm	0905038	<b>£149.53</b>
	150mm	0906038	<b>£161.00</b>
	180mm	0907038	<b>£181.06</b>
	200mm	0908038	<b>£186.08</b>
 <b>Angled Flashing 5 - 45° (Including Storm Collar)</b> Aluminium angled roof flashing including storm collar	125mm	0905035	<b>£150.89</b>
	150mm	0906035	<b>£161.00</b>
	180mm	0907035	<b>£181.06</b>
	200mm	0908035	<b>£186.08</b>
 <b>Storm Collar</b> Used to prevent water ingress where flue passes through a roof flashing	125mm	0905041	<b>£60.24</b>
	150mm	0906041	<b>£62.24</b>
	180mm	0907041	<b>£60.35</b>
	200mm	0908041	<b>£60.35</b>

Product Description	Diameter	Part No.	Price
<b>Seals</b>			
 <b>Female Viton Lip Seal Kit</b> Must be used on every joint for condensing applications	125mm	0905832	<b>£5.40</b>
	150mm	0906832	<b>£6.67</b>
	180mm	0907832	<b>£7.71</b>
	200mm	0908832	<b>£8.28</b>
 <b>Adjustable Pipe Seal Kit</b> Must be used on adjustable pipes for condensing applications	125mm	0905833	<b>£28.25</b>
	150mm	0906833	<b>£35.39</b>
	180mm	0907833	<b>£32.86</b>
	200mm	0908833	<b>£34.90</b>

#### ICID Mitred Bend Dimensions

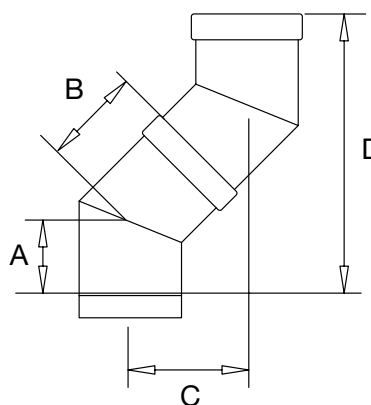

15° Elbow				
Diameter	125	150	180	200
A	63	63	63	64
B	55	56	56	57
C	31	31	31	31
D	232	234	234	238

30° Elbow				
Diameter	125	150	180	200
A	66	70	73	77
B	57	61	64	68
C	62	66	69	73
D	230	244	256	271

45° Elbow				
Diameter	125	150	180	200
A	79	83	91	95
B	70	74	82	86
C	105	111	122	128
D	254	268	295	309

# Typical ICID Plus Installations

## INTERNAL HOUSE Combustible Floors

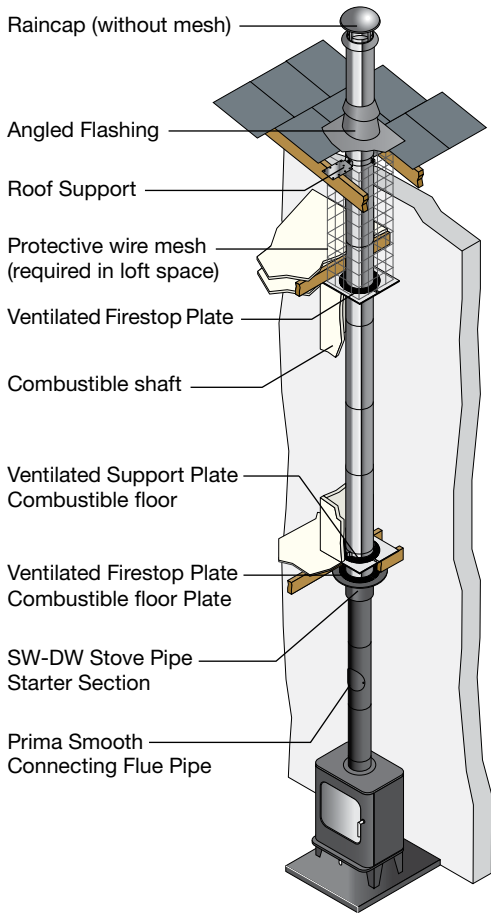

## INTERNAL HOUSE Non Combustible Floors

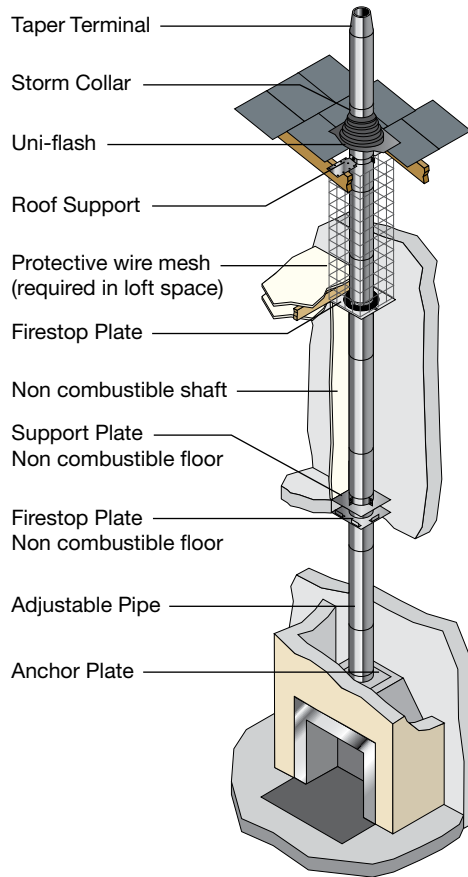

## INTERNAL BUNGALOW (VENTILATED LOFT SPACE) Combustible and Non-Combustible floors

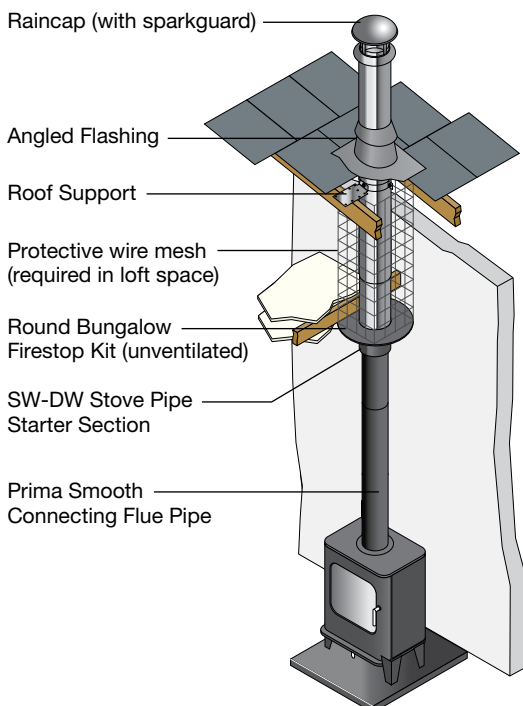

## EXTERNAL System Chimney

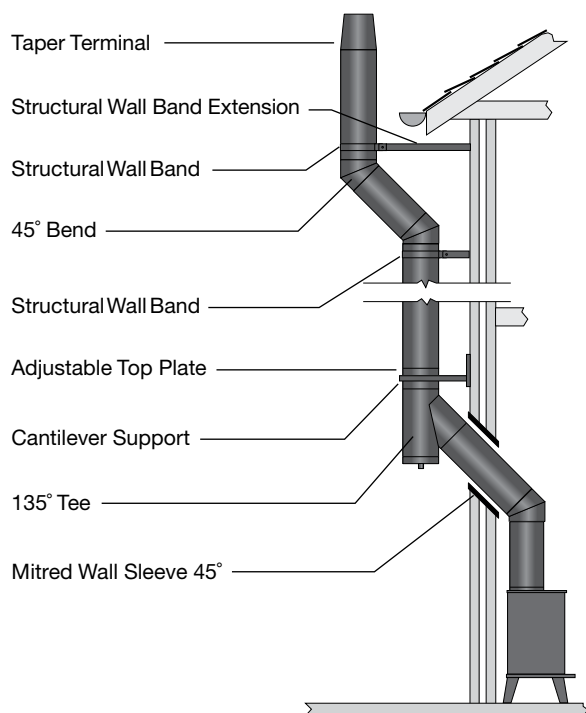



Image courtesy of Schiedel

# ICID Plus Matt Black













**Suitable for:** Woodburning, Solid Fuel, Gas & Oil

**Designation Number:** T200 P1 W V2 L50050 000 (wet systems), T450 N1 D V3 L50050 G50 (in free air / non combustible shaft), T450 N1 D V3 L50050 G60 (in combustible shaft)

Condensing	Locking Bands Req.	Locking Bands Inc.	Distance to Combustibles	Material	Insulation Thickness	Manufacturer	Manufactured in the UK	Warranty
✓ (add seals)	✓	✓	60mm	316 / 304 Stainless Steel	25mm	Schiedel	✓	20 years or lifetime of appliance

Product Description	Diameter	Part No.	Price
<b>Starting Components</b>			
 <b>SW-DW Connector Closed</b> Closed around base for connecting to stove pipe. Must be sealed for a gas tight joint	125mm	0905093MB	<b>£96.74</b>
	150mm	0906093MB	<b>£103.41</b>
 <b>SW-DW Connector (Open Uninsulated)</b> For connecting to stove pipe. Must be sealed for a gas tight joint	125mm	0905094MB	<b>£54.40</b>
	150mm	0906094MB	<b>£60.48</b>
 <b>Insulated Appliance Connector</b> For connecting directly on to appliance	125mm	0905101MB	<b>£155.31</b>
	150mm	0906101MB	<b>£159.78</b>
 <b>Increasing S/W – ICID Adaptor With Case (Insulated)</b> Increasing adaptor from single wall / appliance with step covered by insulated case to provide a more appealing aesthetic	125mm	0905098MB	<b>£119.03</b>
	150mm	0906098MB	<b>£120.92</b>
 <b>Increasing Appliance Connector Closed (Insulated)</b> Closed around base for connecting to stove pipe or directly onto appliance. Must be sealed for a gas tight joint	100 – 125mm	0905097MB	<b>£120.92</b>
	125 – 150mm	0906097MB	<b>£133.03</b>
 <b>SW-DW Starter Pipe 473mm (Short)</b> Gives a tapered increase from single to double wall – must only be used on stove connection pipe not directly onto appliance	125mm	0905103	<b>£196.64</b>
	150mm	0906103	<b>£208.21</b>
 <b>SW-DW Starter Pipe 973mm (Long)</b> Gives a tapered increase from single to double wall – must only be used on stove connection pipe not directly onto appliance	125mm	0905203	<b>£248.69</b>
	150mm	0906203	<b>£260.24</b>

Product Description	Diameter	Part No.	Price
 <b>SW-DW Increasing Starter Pipe 1018mm (Long)</b> Gives a tapered increase from single to twinwall – must only be used on stove connection pipe not directly onto appliance	125 – 150mm	0906104MB	<b>£315.46</b>
 <b>Prima Smooth to ICID Starter Adaptor (Slip In Adaptor)</b> Tapered adaptor designed exclusively for Prima Smooth to slide inside the spigot end of the adaptor, giving a smooth transition to twinwall	150mm	0906099MB	<b>£208.56</b>
 <b>Increasing Prima Smooth Starter Adaptor (Slip In Adaptor)</b> Tapered adaptor designed exclusively for Prima Smooth to slide inside the spigot end of the adaptor, giving a smooth transition to twinwall	125 – 150mm	0906100MB	<b>£221.48</b>
 <b>Prima Smooth to ICID Starter Pipe 1200mm</b> Tapered adaptor designed exclusively for Prima Smooth to slide inside the spigot end of the adaptor, giving a smooth transition to twinwall	125mm	0905201MB	<b>£387.98</b>
	150mm	0906201MB	<b>£415.02</b>
 <b>Adjustable Starter Section 1035mm</b> Designed for ease of use when installing and disconnecting a stove for inspection	125mm	0905014MB	<b>£461.16</b>
	150mm	0906014MB	<b>£317.70</b>
 <b>Adjustable Starter Section 600mm</b> Designed for ease of use when installing and disconnecting a stove for inspection	125mm	0905999MB	<b>£229.45</b>
	150mm	0906999MB	<b>£247.10</b>

Product Description	Diameter	Part No.	Price
<b>Lengths</b>			
	<b>1460mm Straight Length</b>	125mm 0905001MB	<b>£373.58</b>
	Standard straight length of flue	150mm 0906001MB	<b>£392.68</b>
	<b>960mm Straight Length</b>	125mm 0905002MB	<b>£200.73</b>
	Standard straight length of flue	150mm 0906002MB	<b>£227.38</b>
	<b>750mm Straight Length</b>	125mm 0905004MB	<b>£181.39</b>
	Standard straight length of flue	150mm 0906004MB	<b>£199.80</b>
	<b>460mm Straight Length</b>	125mm 0905005MB	<b>£152.36</b>
	Standard straight length of flue	150mm 0906005MB	<b>£167.37</b>
	<b>293mm Straight Length</b>	125mm 0905012MB	<b>£110.03</b>
	Standard straight length of flue	150mm 0906012MB	<b>£118.74</b>
	<b>160mm Straight Length</b>	125mm 0905006MB	<b>£97.96</b>
	Standard straight length of flue	150mm 0906006MB	<b>£106.48</b>
	<b>50 – 230mm Telescopic Length (1 Piece)</b>	125mm 0905015MB	<b>£225.22</b>
	1 Piece section used to add length to a standard length	150mm 0906015MB	<b>£181.39</b>
	<b>350 – 570mm Adjustable Length</b>	125mm 0905016MB	<b>£247.92</b>
	2 Piece adjustable sliding length	150mm 0906016MB	<b>£253.98</b>
	<b>215 – 310mm Adjustable Length</b>	125mm 0905018MB	<b>£223.70</b>
	2 Piece adjustable sliding length	150mm 0906018MB	<b>£229.76</b>
	<b>585 – 885mm Adjustable Length</b>	125mm 0905017MB	<b>£268.57</b>
	2 piece adjustable sliding length	150mm 0906017MB	<b>£285.86</b>
	<b>Locking Band</b>	125mm 0905086MB	<b>£12.09</b>
	Standard fastening for joints, included as standard on all ICID Plus parts with a female collar / socket joint	150mm 0906086MB	<b>£12.26</b>
	<b>Inspection Pipe with Test Point (Dry Applications Only)</b>	125mm 0905013 DMB	<b>£375.92</b>
	Installed as a standard length the inspection hatch offers facility for flue access & cleaning and a locking plug with a lip seal gasket. 302mm installed length	150mm 0906013 DMB	<b>£422.80</b>



Product Description	Diameter	Part No.	Price
<b>Elbows / Tees</b>			
	<b>15° Elbow</b>	125mm 0905025MB	<b>£164.46</b>
	Used for changing flue direction	150mm 0906025MB	<b>£191.07</b>
	<b>30° Elbow</b>	125mm 0905023MB	<b>£164.46</b>
	Used for changing flue direction	150mm 0906023MB	<b>£191.03</b>
	<b>45° Elbow</b>	125mm 0905022MB	<b>£164.46</b>
	Used for changing flue direction	150mm 0906022MB	<b>£191.03</b>
	<b>90° Elbow</b>	150mm 0906021MB	<b>£239.42</b>
	<b>90° Tee Including Cap (Cap Suitable For Tee Only)</b>	125mm 0905043MB	<b>£460.74</b>
	Connect from connecting flue pipe to a chimney system or the branch may be used to locate a draft stabiliser, complete with drain cap for base	150mm 0906043MB	<b>£502.99</b>
	<b>135° Tee Including Cap (Cap Suitable For Tee Only)</b>	125mm 0905044MB	<b>£430.50</b>
	Used in combination with a 45° bend from connecting flue pipe to a chimney system, complete with drain cap for base	150mm 0906044MB	<b>£502.99</b>
	<b>Tee Cap</b>	150mm 0906091MB	<b>£60.48</b>
	<b>Insulated Tee Cap (Fits Wall Support Top Plate)</b>	125mm 0905053MB	<b>£178.38</b>
	Tee cap designed to fit onto tee or any ICID fitting	150mm 0906053MB	<b>£188.95</b>
	<b>Insulated Tee Cap &amp; Drain (Fits Wall Support Top Plate)</b>	125mm 0905533MB	<b>£177.70</b>
	Tee cap designed to fit onto tee or any ICID fitting with added drain off fitting	150mm 0906533MB	<b>£193.66</b>









## Do you need?





Guy Wire, Grips and Strainers or Rigid Roof Stays





See the Fixings section on page 5.10



Product Description	Diameter	Part No.	Price
<b>Support / Penetration Components</b>			
 <b>Top Plate</b> Supporting plate with socket above and spigot below. Can use with side plates or cantilever brackets for the weight bearing wall supports (includes locking band)	125mm	0905066MB	<b>£161.28</b>
	150mm	0906066MB	<b>£169.28</b>
 <b>Wall Support Side Plates</b> Triangular side plates for standard wall support offering 60mm distance away from wall	125mm	0905994MB	<b>£139.07</b>
	150mm	0906994MB	<b>£151.18</b>
 <b>Standard Wall Support 60mm Stand Off</b> Support plate with triangular side plates for standard wall support offering 60mm distance away from wall	125mm	0905998MB	<b>£296.27</b>
	150mm	0906998MB	<b>£320.46</b>
 <b>Adj Wall Support 100mm Stand Off (Type 325 Arms)</b> Support plate with 325mm cantilever arms allowing up to 100mm extension distance away from wall	125mm	0905325MB	<b>£354.92</b>
	150mm	0906325MB	<b>£362.78</b>
 <b>Adj Wall Support 100 - 250mm Stand Off (Type 475 Arms)</b> Support plate with 475mm cantilever brackets allowing up to 250mm extension distance away from wall	125mm	0905475MB	<b>£372.54</b>
	150mm	0906475MB	<b>£380.91</b>
 <b>Adj Wall Support 100 - 350mm Stand Off (Type 570 Arms)</b> Support plate with 570mm cantilever brackets allowing up to 350mm extension distance away from wall	125mm	0905570MB	<b>£429.28</b>
	150mm	0906570MB	<b>£441.65</b>
 <b>Retrofit Wall Support</b> Band with triangular side plates providing 60-200mm stand off	125mm	0905200MB	<b>£149.63</b>
	150mm	0906200MB	<b>£151.62</b>
 <b>Wall Band 60mm</b> Standard lateral support wall band (suitable for internal & external application)	125mm	0905088MB	<b>£41.73</b>
	150mm	0906088MB	<b>£43.36</b>



Product Description	Diameter	Part No.	Price
 <b>Wall Band Extension 50 - 100mm</b> Back bracket allowing extension of flue when using 09**088MB	125mm	0905064MB	<b>£13.03</b>
	150mm	0906064MB	<b>£26.20</b>
 <b>Adjustable Wall Band 60 - 300mm (Band &amp; Bracket)</b> 09**088MB & 09**067MB combined as an extension band and bracket kit	125mm	0905067MB	<b>£95.02</b>
	150mm	0906067MB	<b>£128.09</b>
 <b>Retrofit Wall Band 60mm</b> Can be used on their own or combined with extension brackets for further adjustment	125mm	0905088 RFMB	<b>£90.15</b>
	150mm	0906088 RFMB	<b>£94.74</b>
 <b>Structural Wall Band Extension W1 - 130mm</b> Short brackets to offer up to 100mm extension away from wall for retrofit wall bands	One Size	0900001MB	<b>£57.97</b>
 <b>Structural Wall Band Extension L1 - 300mm</b> Extension arms to allow up to 250mm extension away from wall for retrofit wall bands	One Size	0900002MB	<b>£170.12</b>
 <b>Structural Wall Band Extension L2 - 450mm</b> Extension arms to allow up to 440mm extension away from wall for retrofit wall bands	One Size	0900003MB	<b>£181.39</b>
 <b>Guy Wire Bracket</b> Used to secure unsupported chimney sections above the roof level with wires or rigid stays	125mm	0905092MB	<b>£49.30</b>
	150mm	0906092MB	<b>£46.13</b>
 <b>Extended / Structural Locking Band</b> Used where the flue is freestanding above the roof and height exceeds 1.5m above the last support or roof Can support up to 3m from last support	125mm	0905086 EMB	<b>£40.86</b>
	150mm	0906086 EMB	<b>£42.65</b>
 <b>Structural Locking Band For Bend</b> As the extended standard locking bands but thinner to allow fitting on bends where offset is used	125mm	0905086 EBMB	<b>£18.15</b>
	150mm	0906086 EBMB	<b>£18.14</b>

Product Description	Diameter	Part No.	Price
 <b>90° Trim Collar One Piece</b> To cover when chimney system passes through a wall Covers 100mm (125 & 150mm) or 75mm (180 & 200mm) around external diameter of the flue	125mm	0905111B	<b>£63.97</b>
	150mm	0906111B	<b>£64.92</b>
	180mm	0907105B	<b>£79.09</b>
	200mm	0908105B	<b>£90.54</b>
 <b>135° Trim Collar One Piece</b> To cover when chimney system passes through the wall at 135° Covers 100mm (125 & 150mm) or 75mm (180 & 200mm) around external diameter of the flue	125mm	0905113B	<b>£74.95</b>
	150mm	0906113B	<b>£83.21</b>
	180mm	0907106B	<b>£114.85</b>
	200mm	0908106B	<b>£119.27</b>
 <b>135° Trim Collar Two Piece</b> To cover when chimney system passes through the wall at 135° Covers 100mm (125 & 150mm) or 75mm (180 & 200mm) around external diameter of the flue	125mm	0905114B	<b>£70.74</b>
	150mm	0906114B	<b>£77.68</b>
	180mm	0907107B	<b>103.57</b>
	200mm	0908107B	<b>£110.37</b>
 <b>0 – 20° Trim Collar Two Piece</b> Elliptical collar allowing multiple angles between 0 – 20°	125mm	0905245B	<b>£82.81</b>
	150mm	0906245B	<b>£75.82</b>
	180mm	0907245B	<b>£96.06</b>
	200mm	0908245B	<b>£101.11</b>







Product Description	Diameter	Part No.	Price
 <b>20 – 35° Trim Collar Two Piece</b> Elliptical collar allowing multiple angles between 20 – 35°	125mm	0905246B	<b>£75.82</b>
	150mm	0906246B	<b>£75.82</b>
	180mm	0907246B	<b>£96.06</b>
	200mm	0908246B	<b>£101.11</b>
 <b>35 – 45° Trim Collar Two Piece</b> Elliptical collar allowing multiple angles between 35 – 45°	125mm	0905247B	<b>£75.82</b>
	150mm	0906247B	<b>£75.82</b>
	180mm	0907247B	<b>£96.06</b>
	200mm	0908247B	<b>£100.43</b>
 <b>Ventilated Firestop Round One Piece Black (Combustible Floor)</b> To be used where chimney passes through a combustible floor or ceiling	125mm	0905083B	<b>£89.38</b>
	150mm	0906083B	<b>£89.38</b>
	180mm	0907083B	<b>£99.89</b>
	200mm	0908083B	<b>£110.42</b>
 <b>Ventilated Firestop Round Two Piece Black (Combustible Floor)</b> To be used where chimney passes through a combustible floor or ceiling	125mm	0905084B	<b>£89.38</b>
	150mm	0906084B	<b>£94.63</b>
	180mm	0907084B	<b>£110.42</b>
	200mm	0908084B	<b>£115.68</b>







Product Description	Diameter	Part No.	Price
 <b>Bungalow Circular Firestop One Piece Black (Unvented)</b> Used for when chimney passes through a combustible ceiling in a bungalow into an open roof space	125mm	0905183B	<b>£55.99</b>
	150mm	0906183B	<b>£59.98</b>
	180mm	0907183B	<b>£68.62</b>
	200mm	0908183B	<b>£73.60</b>
 <b>Magnetic Cover Ring Black</b> Optional decorative addition to ventilated firestop plate	125mm	0905110B	<b>£62.59</b>
	150mm	0906110B	<b>£62.59</b>
	180mm	0907110B	<b>£72.22</b>
	200mm	0908110B	<b>£72.22</b>

#### Terminals / Flashings

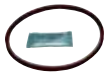
 <b>Rain Cap No Mesh</b> Rain Cap terminal without mesh, terminates flue and offers rain protection	125mm	0905074MB	<b>£108.87</b>
	150mm	0906074MB	<b>£114.79</b>
 <b>Rain Cap With Mesh</b> Rain Cap terminal with 25mm anti-bird mesh, terminates flue and offers rain protection	125mm	0905076MB	<b>£133.02</b>
	150mm	0906076MB	<b>£139.06</b>
 <b>Anti Splash Terminal (Without Mesh)</b> Some antidowndraught properties, terminates flue and helps reduce downdraught and rain entering the chimney system	150mm	0906075MB	<b>£338.65</b>
 <b>Insulated Tapered Terminal</b> Open tapered terminal, terminates chimney system	125mm	0905073MB	<b>£193.48</b>
	150mm	0906073MB	<b>£231.41</b>
 <b>Round Terminal</b> Terminal offering extra protection in excessive rain	125mm	0905079MB	<b>£234.32</b>
	150mm	0906079MB	<b>£250.33</b>
 <b>Angled Flashing 5 – 45° (Including Storm Collar)</b> Aluminium angled roof flashing including storm collar	150mm	0906035MB	<b>£343.67</b>
 <b>Storm Collar</b> Used to prevent water ingress where flue passes through a roof flashing	125mm	0905041MB	<b>£72.31</b>
	150mm	0906041MB	<b>£72.31</b>

Product Description	Diameter	Part No.	Price
<b>Seals</b>			
 <b>Female Viton Lip Seal Kit</b> Must be used on every joint for condensing applications	125mm	0905832	<b>£5.40</b>
	150mm	0906832	<b>£6.67</b>
	180mm	0907832	<b>£7.71</b>
	200mm	0908832	<b>£8.28</b>
 <b>Adjustable Pipe Seal Kit</b> Must be used on adjustable pipes for condensing applications	125mm	0905833	<b>£28.25</b>
	150mm	0906833	<b>£35.39</b>
	180mm	0907833	<b>£32.86</b>
	200mm	0908833	<b>£34.90</b>