

ESP-10

Flue Gas Particle Filter / Wood Stove Filter

exodraft wood stove filter ESP-10 is an electrostatic flue gas particle filter designed to remove most of the hazardous ultrafine particles contained in the flue gasses from your wood stove or fireplace.

The electrostatic precipitator (ESP) comes with an automatic cleaning function which helps to maintain a high filtering efficiency while keeping maintenance requirements at a minimum.

Model ESP-10

Application	Closed, wood-fired appliances
Fireplace performance range	2-10 kW
Min. ambient temperature	-20 °C
Max. flue gas temperature	500 °C
Max. ambient temperature	45 °C
IP	24D
Supply voltage	230 V AC / 50 Hz
Max. current	0.5 Amp
Power consumption in use	50-90 W
Power consumption in standby	2 W
High voltage	30 kV / 1.7 mA
Testing done at	DIBt: Z-7.4-3536
Housing material	RF 1.4401-316
Min. distance to flammable material	500 mm
Mounting	Outside, on chimney top

Dimensions & weight

Chimney size - round	ø150 - ø200 mm
Chimney size - square (max.)	250 x 250 mm
Height	H: 956 mm
Outer diameter	ø268 mm
Weight (without adapter)	14 kg

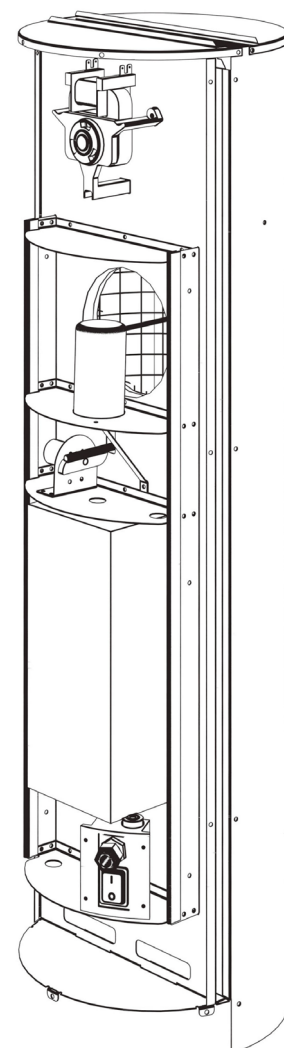

Filtering effect:

95% reduction in number of particles
 70-75% reduction in total particle mass

Universal mounting adapters

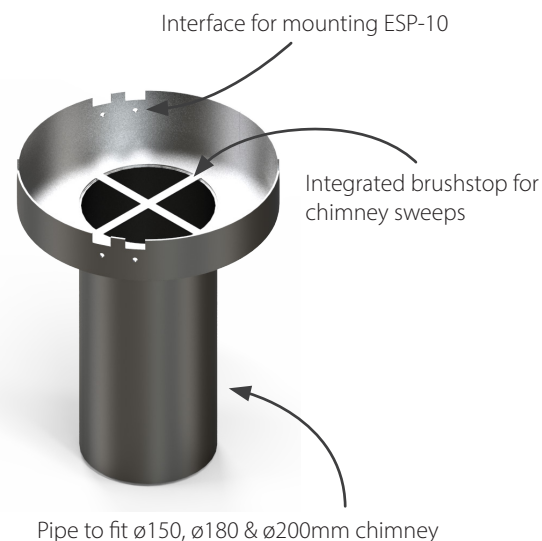
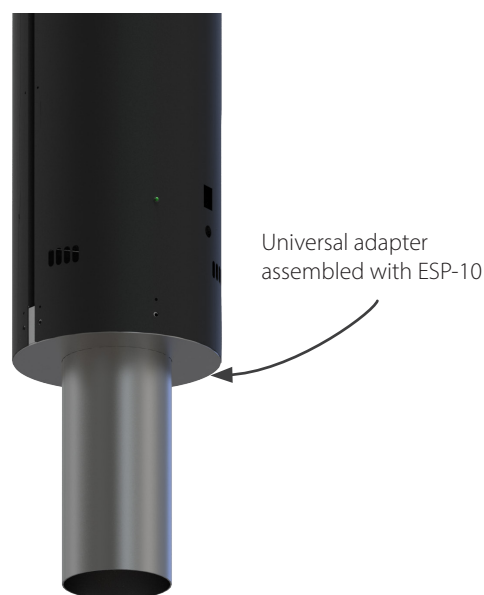

Dimensions

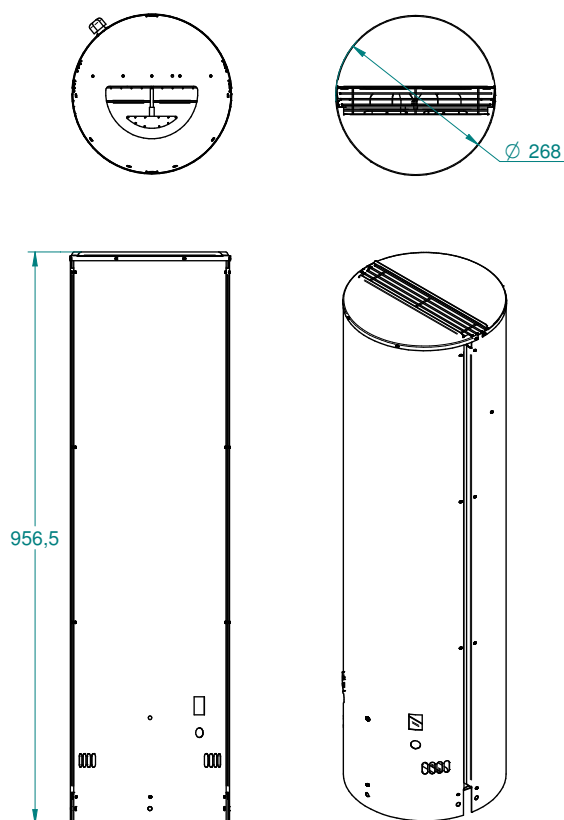

Mounting adapters



exodraft a/s
Industrivej 10
5550 Langeskov
Denmark

www.exodraft.com

