



# Product list 2018/19

Stoves and accessories

English



## TT wood burning stoves

Product	Description	Colour	Item no.:
	<p>TT10 6kW Distance to combustible: Back: 20cm – Side: 20cm – Corner: 20cm</p> <p>Optional accessories:</p> <ul style="list-style-type: none"> <li>• 09-162 Fresh air/combustion air collar</li> <li>• 45-710 Direct air connection kit Ø80</li> <li>• 30-907 Form glass plate</li> <li>• Soapstone top plate</li> <li>• *Remember rubber feet for stove 09-912</li> </ul>	black	<b>S01-400</b>
	<p>TT10S 6kW Distance to combustible: Back: 20cm – Side: 20cm – Corner: 20cm</p> <p>Optional accessories:</p> <ul style="list-style-type: none"> <li>• 09-162 Fresh air/combustion air collar</li> <li>• 45-710 Direct air connection kit Ø80</li> <li>• 30-907 Form glass plate</li> <li>• *Remember rubber feet for stove 09-912</li> </ul>	black Top exit	<b>S01-410</b>
	<p>TT10G 6kW Distance to combustible: Back: 10cm – Side: 45cm – Corner: 45cm</p> <p>Optional accessories:</p> <ul style="list-style-type: none"> <li>• 09-162 Fresh air/combustion air collar</li> <li>• 45-710 Direct air connection kit Ø80</li> <li>• 30-907 Form glass plate</li> <li>• Soapstone top plate</li> <li>• *Remember rubber feet for stove 09-912</li> </ul>	black	<b>S01-440</b>
	<p>TT20 Streamline 5kW Distance to combustible: Back: 15cm – Side: 35cm – Corner: 12,5cm</p> <p>Optional accessories:</p> <ul style="list-style-type: none"> <li>• 09-162 Fresh air/combustion air collar</li> <li>• 45-710 Direct air connection kit Ø80</li> <li>• 09-164 Log stopper</li> </ul>	black	<b>S01-606</b>

## TT wood burning stoves

Product	Description	Colour	Item no.:
	<p>TT20 Streamline R 5kW Distance to combustible: Back: 15cm – Side: 35cm – Corner: 12,5cm</p> <p>Optional accessories:</p> <ul style="list-style-type: none"> <li>• 09-162 Fresh air/combustion air collar</li> <li>• 45-710 Direct air connection kit Ø80</li> <li>• 09-164 Log stopper</li> <li>• 09-518 Cover for compartment</li> </ul>	black	<b>S01-608</b>
	<p>TT20 5kW Distance to combustible: Back: 15cm – Side: 35cm – Corner: 12,5cm</p> <p>Optional accessories:</p> <ul style="list-style-type: none"> <li>• 09-162 Fresh air/combustion air collar</li> <li>• 45-710 Direct air connection kit Ø80</li> <li>• 09-164 Log stopper</li> <li>• 30-911/30-907 Form glass plate (Scandinavia / rest EU)</li> <li>• 09-522 / 09-523 Door for wood compartment</li> <li>• 09-524 Fire tool set for wood compartment door</li> </ul>	black	<b>S01-600</b>
		dark grey	<b>S01-601</b>
	<p>TT20R 5kW Distance to combustible: Back: 15cm – Side: 35cm – Corner: 12,5cm</p> <p>Optional accessories:</p> <ul style="list-style-type: none"> <li>• 09-162 Fresh air/combustion air collar</li> <li>• 45-710 Direct air connection kit Ø80</li> <li>• 09-164 Log stopper</li> <li>• 30-911/30-907 Form glass plate (Scandinavia / rest EU)</li> <li>• 09-522 / 09-523 Door for wood compartment</li> <li>• 09-524 Fire tool set for wood compartment door</li> </ul>	black	<b>S01-602</b>
		dark grey	<b>S01-603</b>
	<p>TT20S 5kW Distance to combustible: Back: 15cm – Side: 35cm – Corner: 12,5cm</p> <p>Optional accessories:</p> <ul style="list-style-type: none"> <li>• 09-162 Fresh air/combustion air collar</li> <li>• 45-710 Direct air connection kit Ø80</li> <li>• 09-164 Log stopper</li> <li>• 30-911/30-907 Form glass plate (Scandinavia / rest EU)</li> <li>• 09-526/09-527 Door 360° for wood compartment</li> <li>• 09-524 Fire tool set for wood compartment door</li> </ul>	black Top/rear exit	<b>S01-618</b>
		dark grey Top/rear exit	<b>S01-619</b>

## TT wood burning stoves

Product	Description	Colour	Item no.:
	<p>TT20RS 5kW Distance to combustible: Back: 15cm – Side: 35cm – Corner: 12,5cm</p> <p>Optional accessories:</p> <ul style="list-style-type: none"> <li>• 09-162 Fresh air/combustion air collar</li> <li>• 45-710 Direct air connection kit Ø80</li> <li>• 09-164 Log stopper</li> <li>• 30-911/30-907 Form glass plate (Scandinavia / rest EU)</li> <li>• 09-526/09-527 Door 360° for wood compartment</li> <li>• 09-524 Fire tool set for wood compartment door</li> </ul>	black Top/rear exit	<b>S01-620</b>
		dark grey Top/rear exit	<b>S01-621</b>
	TT20RS with base stone	black	<b>S01-620 + 08-424</b>
		dark grey	<b>S01-621 + 08-424</b>
	TT20RS with base stone and Heat storage	black	<b>S01-620 + 08-422 + 08-424</b>
		dark grey	<b>S01-620 + 08-422 + 08-424</b>
	<p>TT20SA 5kW Distance to combustible: Back: 15cm – Side: 35cm – Corner: 12,5cm</p> <p>Optional accessories:</p> <ul style="list-style-type: none"> <li>• 09-162 Fresh air/combustion air collar</li> <li>• 45-710 Direct air connection kit Ø80</li> <li>• 09-164 Log stopper</li> <li>• 30-911/30-907 Form glass plate (Scandinavia / rest EU)</li> <li>• 09-526/09-527 Door 360° for wood compartment</li> <li>• 09-524 Fire set tool for wood compartment door</li> </ul>	black	<b>S01-626</b>

## TT wood burning stoves

Product	Description	Colour	Item no.:
	<p>TT21RL 5kW Distance to combustible: Back: 15cm – Side: 35cm – Corner: 12,5cm</p> <p>Optional accessories:</p> <ul style="list-style-type: none"> <li>• 09-162 Fresh air/combustion air collar</li> <li>• 45-710 Direct air connection kit Ø80</li> <li>• 09-164 Log stopper</li> <li>• 30-911/30-907 Form glass plate (Scandinavia / rest EU)</li> </ul>	black	<b>S01-628</b>
	<p>TT21R 5kW Distance to combustible: Back: 15cm – Side: 35cm – Corner: 12,5cm</p> <p>Optional accessories:</p> <ul style="list-style-type: none"> <li>• 09-162 Fresh air/combustion air collar</li> <li>• 45-710 Direct air connection kit Ø80</li> <li>• 09-164 Log stopper</li> <li>• 30-911/30-907 Form glass plate (Scandinavia / rest EU)</li> <li>• 09-874 Door for wood compartment</li> <li>• 09-524 Fire tool set for wood compartment door</li> </ul>	black	<b>S01-630</b>
	<p>TT21RH 5kW Distance to combustible: Back: 15cm – Side: 35cm – Corner: 12,5cm</p> <p>Optional accessories:</p> <ul style="list-style-type: none"> <li>• 09-162 Fresh air/combustion air collar</li> <li>• 45-710 Direct air connection kit Ø80</li> <li>• 09-164 Log stopper</li> <li>• 30-911/30-907 Form glass plate (Scandinavia / rest EU)</li> <li>• 09-524 Fire tool set for wood compartment door</li> </ul>	black	<b>S01-636</b>
	<p>TT21RLS 5kW Distance to combustible: Back: 15cm – Side: 35cm – Corner: 12,5cm</p> <p>Optional accessories:</p> <ul style="list-style-type: none"> <li>• 09-162 Fresh air/combustion air collar</li> <li>• 45-710 Direct air connection kit Ø80</li> <li>• 09-164 Log stopper</li> <li>• 30-911/30-907 Form glass plate (Scandinavia / rest EU)</li> </ul>	black	<b>S01-634</b>

## TT wood burning stoves

Product	Description	Colour	Item no.:
	<p>TT21RS 5kW Distance to combustible: Back: 15cm – Side: 35cm – Corner: 12,5cm</p> <p>Optional accessories:</p> <ul style="list-style-type: none"> <li>• 09-162 Fresh air/combustion air collar</li> <li>• 45-710 Direct air connection kit Ø80</li> <li>• 09-164 Log stopper</li> <li>• 30-911/30-907 Form glass plate (Scandinavia / rest EU)</li> <li>• 09-874 / 09-875 Door for wood compartment</li> <li>• 09-524 Fire tool set for wood compartment door</li> </ul>	black	<b>S01-632</b>
	<p>TT21RHS 5kW Distance to combustible: Back: 15cm – Side: 35cm – Corner: 12,5cm</p> <p>Optional accessories:</p> <ul style="list-style-type: none"> <li>• 09-162 Fresh air/combustion air collar</li> <li>• 45-710 Direct air connection kit Ø80</li> <li>• 09-164 Log stopper</li> <li>• 30-911/30-907 Form glass plate (Scandinavia / rest EU)</li> <li>• 09-524 Fire tool set for wood compartment door</li> </ul>	black	<b>S01-638</b>
	<p>TT21RS Black (black painted soapstone) 5kW Distance to combustible: Back: 15cm – Side: 35cm – Corner: 12,5cm</p> <p>Optional accessories:</p> <ul style="list-style-type: none"> <li>• 09-162 Fresh air/combustion air collar</li> <li>• 45-710 Direct air connection kit Ø80</li> <li>• 09-164 Log stopper</li> <li>• 30-911/30-907 Form glass plate (Scandinavia / rest EU)</li> <li>• 09-874 Door for wood compartment</li> <li>• 09-524 Fire tool set for wood compartment door</li> </ul>	black	<b>S01-624</b>
	<p>TT22 7,5kW Distance to combustible: Back: 15cm – Side: 45cm – Corner: 15cm</p> <p>Optional accessories:</p> <ul style="list-style-type: none"> <li>• 09-552 Fresh air/combustion air collar</li> <li>• 45-712 Direct air connection kit Ø100</li> <li>• 30-910 Form glass plate</li> </ul>	black	<b>S01-640</b>
		dark grey	<b>S01-641</b>

## TT wood burning stoves

Product	Description	Colour	Item no.:
	<p>TT22R 7,5kW Distance to combustible: Back: 15cm – Side: 45cm – Corner: 15cm</p> <p>Optional accessories:</p> <ul style="list-style-type: none"> <li>• 09-552 Fresh air/combustion air collar</li> <li>• 45-712 Direct air connection kit Ø100</li> <li>• 30-910 Form glass plate</li> </ul>	black	<b>S01-648</b>
	<p>TT22RP 7,5kW Distance to combustible: Back: 15cm – Side: 45cm – Corner: 15cm</p> <p>Optional accessories:</p> <ul style="list-style-type: none"> <li>• Fresh air/combustion air collar Inclusive</li> <li>• 45-712 Direct air connection kit Ø100</li> <li>• 30-910 Form glass plate</li> </ul>	black	<b>S01-654</b>
	<p>TT22S 7,5kW Distance to combustible: Back: 15cm – Side: 45cm – Corner: 15cm</p> <p>Optional accessories:</p> <ul style="list-style-type: none"> <li>• 09-552 Fresh air/combustion air collar</li> <li>• 45-712 Direct air connection kit Ø100</li> <li>• 30-910 Form glass plate</li> <li>• 09-556 Cooking plate set for soapstone top</li> </ul>	black	<b>S01-642</b>
		dark grey	<b>S01-643</b>
	<p>TT22HST 7,5kW Distance to combustible: Back: 15cm – Side: 45cm – Corner: 15cm</p> <p>Optional accessories:</p> <ul style="list-style-type: none"> <li>• 09-552 Fresh air/combustion air collar</li> <li>• 45-712 Direct air connection kit Ø100</li> <li>• 30-910 Form glass plate</li> <li>• 09-556 Cooking plate set for soapstone top</li> </ul>	black	<b>S01-650</b>
		dark grey	<b>S01-651</b>

## TT wood burning stoves

Product	Description	Colour	Item no.:
	<p>TT22H 7,5kW Distance to combustible: Back: 15cm – Side: 45cm – Corner: 15cm</p> <p>Optional accessories:</p> <ul style="list-style-type: none"> <li>• Fresh air/combustion air collar Inclusive</li> <li>• 45-712 Direct air connection kit Ø100</li> <li>• 30-910 Form glass plate</li> </ul>	black	<b>S01-644</b>
		dark grey	<b>S01-645</b>
	<p>TT22HS 7,5kW Distance to combustible: Back: 15cm – Side: 45cm – Corner: 15cm</p> <p>Optional accessories:</p> <ul style="list-style-type: none"> <li>• 09-552 Fresh air/combustion air collar</li> <li>• 45-712 Direct air connection kit Ø100</li> <li>• 30-910 Form glass plate</li> <li>• 09-556 Cooking plate set for soapstone top</li> </ul>	black	<b>S01-646</b>
		dark grey	<b>S01-647</b>
	<p>TT30 5kW Distance to combustible: Back: 10cm – Side: 35cm – Corner: 17cm</p> <p>Optional accessories:</p> <ul style="list-style-type: none"> <li>• Fresh air/combustion air collar Inclusive</li> <li>• 45-710 Direct air connection kit Ø80</li> <li>• 30-908/30-909 Form glass plate (Scandinavia / rest EU)</li> <li>• 09-524 Fire tool set for wood compartment door</li> </ul>	black	<b>S01-730</b>
	<p>TT30G 5kW Distance to combustible: Back: 10cm – Side: 49cm – Corner: 49cm</p> <p>Optional accessories:</p> <ul style="list-style-type: none"> <li>• Fresh air/combustion air collar Inclusive</li> <li>• 45-710 Direct air connection kit Ø80</li> <li>• 30-908/30-909 Form glass plate (Scandinavia / rest EU)</li> <li>• 09-524 Fire tool set for wood compartment door</li> </ul>	black	<b>S01-732</b>









## TT wood burning stoves

Product	Description	Colour	Item no.:
	<p>TT30S 5kW Distance to combustible: Back: 10cm – Side: 35cm – Corner: 17cm</p> <p>Optional accessories:</p> <ul style="list-style-type: none"> <li>• Fresh air/combustion air collar Inclusive</li> <li>• 45-710 Direct air connection kit Ø80</li> <li>• 30-908/30-909 Form glass plate (Scandinavia / rest EU)</li> <li>• 09-524 Fire tool set for wood compartment door</li> </ul>	black	<b>S01-734</b>
	<p>TT30GS 5kW Distance to combustible: Back: 10cm – Side: 49cm – Corner: 49cm</p> <p>Optional accessories:</p> <ul style="list-style-type: none"> <li>• Fresh air/combustion air collar Inclusive</li> <li>• 45-710 Direct air connection kit Ø80</li> <li>• 30-908/30-909 Form glass plate (Scandinavia / rest EU)</li> <li>• 09-524 Fire tool set for wood compartment door</li> </ul>	black	<b>S01-736</b>
	<p>TT60 6kW Distance to combustible: Back: 7,5cm – Side: 35cm – Corner: 5cm</p> <p>Possible accessory:</p> <ul style="list-style-type: none"> <li>• 30-912 / 30-913 Form glass plate (Scandinavia / rest EU) (can not be used for corner installation)</li> </ul>	black	<b>S01-670</b>
	<p>TT60S 6kW Distance to combustible: Back: 7,5cm – Side: 35cm – Corner: 5cm</p> <p>Possible accessory:</p> <ul style="list-style-type: none"> <li>• 30-912 / 30-913 Form glass plate (Scandinavia / rest EU) (can not be used for corner installation)</li> </ul>	black	<b>S01-672</b>

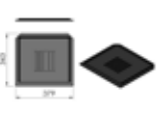









## TT wood burning stoves

Product	Description	Colour	Item no.:
	<p>TT60W 6kW Distance to combustible: Back: 7,5cm – Side: 35cm – Corner: 5cm</p> <p>Optional accessories:</p> <ul style="list-style-type: none"> <li>• 09-696 Fresh air/combustion air collar rear (backward)</li> <li>• 09-698 Fresh air/combustion air collar normal (downward)</li> </ul>	black	<b>S01-674</b>









## Spare parts for TT wood-burning stoves

Product	Description	Colour	Item no.
	<b>TT1, TT1Z, TT1W spare parts</b>		
	TT1+TT1W Complete door	light grey	<b>09-101</b>
	TT1 Glass 360 x 402mm		<b>09-108</b>
	TT1+TT2+TT3+TT10 Complete door handle		<b>09-109</b>
	TT1 Cast iron frame		<b>09-111</b>
	TT1 Cast iron bottom for combustion chamber		<b>09-112</b>
	TT1 Ash drawer	black	<b>09-120</b>
	* As long as stock is available	light grey	<b>09-121</b>
	TT1 Vermiculite complete		<b>09-130</b>
	TT1Z Complete door	black	<b>09-300</b>
	* As long as stock is available		
	TT1Z Ash drawer	black	<b>09-302</b>
	* As long as stock is available	light grey	<b>09-303</b>
	TT1+TT2+TT3+TT10 Bauart door spring + pin		<b>09-110</b>
	TT1+TT2+TT3 Smoke guide plate - steel		<b>09-137</b>
	TT1+TT2+TT3 Vermiculite smoke guide plate 350x310		<b>09-131</b>



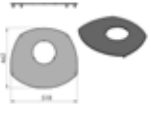



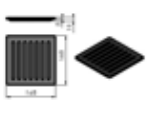





## Spare parts for TT wood-burning stoves

Product	Description	Colour	Item no.
	TT1+TT1Z+TT2+TT3+TT10+TT20+TT30 Gasket for doorframe Ø14mm (FD3212W)		<b>09-623</b>
	TT1+TT2+TT3+TT10+TT20+TT21+TT22+ TT30+TT40+TT60 Gasket for glass and ash drawer Ø6mm		<b>09-634</b>
	<b>TT2, TT3 spare parts</b>		
	TT2+TT3 Glass		<b>09-208</b>
	TT2+TT3 Cast iron bottom for combustion chamber unpainted		<b>09-212</b>
	TT2+TT3 Ash drawer	black	<b>09-220</b>
	* As long as stock is available	light grey	<b>09-221</b>
	TT2+TT3 Vermiculite complete		<b>09-230</b>
	TT2+TT3 Vermiculite bended front piece		<b>09-231</b>
	TT1+TT2+TT3 Vermiculite smoke guide plate		<b>09-131</b>
	TT1+TT2+TT3 Smoke guide plate - steel		<b>09-137</b>
	TT1+TT1Z+TT2+TT3+TT10+TT20+TT30 Gasket for doorframe Ø14mm (D3212W)		<b>09-623</b>
	TT1+TT2+TT3+TT10+TT20+TT21+TT22+ TT30+TT40+TT60 Gasket for glass and ash drawer Ø6mm		<b>09-634</b>

## Spare parts for TT wood-burning stoves









Product	Description	Colour	Item no.
	<b>TT10 spare parts</b>		
	TT10+TT20+TT21 (-Bazic) Form glass plate	glass	<b>30-907</b>
	TT10+TT20+TT21 (-Bazic) Form glass plate (Scandinavian)	glass	<b>30-911</b>
	TT10+TT20+TT21 Fresh air collar (Remember 45-710)	black	<b>09-162</b>
	Direct air connection kit – single connector Contains: Fresh air vent grid, Wall bushing, rosette, insulation, 2 clamps and damper regulation rod	Ø80	<b>45-710</b>
	Direct air connection kit for floor 80/100mm. Contains: 1m. aluflex pipe, 1m. insulation hose, 1 galvanized transition, 2 clamps	Ø80	<b>45-720</b>
	TT10 Top plate steel	black	<b>09-142</b>
		light grey	<b>09-143</b>
	TT10 Steel side – right (seen from the front)	black	<b>09-144</b>
		light grey	<b>09-145</b>
	TT10 Steel side - left (seen from the front)	black	<b>09-146</b>
		light grey	<b>09-147</b>
	TT10 Glass		<b>09-308</b>
	TT10 Cast iron frame unpainted		<b>09-311</b>
	TT10 Cast iron bottom without grate		<b>09-312</b>
	TT10+TT20+TT21+TT22+TT30+TT60 Grate for cast iron bottom		<b>09-313</b>

## Spare parts for TT wood-burning stoves

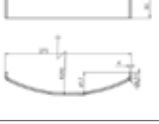









Product	Description	Colour	Item no.
	TT10 Vermiculite complete		<b>09-310</b>
	TT10G Vermiculite complete		<b>09-318</b>
	TT10 Ash drawer	black	<b>09-320</b>
	TT10 Complete door	black	<b>09-400</b>
		light grey	<b>09-401</b>
	TT10 Door for wood compartment	black	<b>09-402</b>
		light grey	<b>09-403</b>
	TT1+TT1Z+TT2+TT3+TT10+TT20+TT30 Gasket for doorframe Ø14mm (FD3212W)		<b>09-623</b>
	TT1+TT2+TT3+TT10+TT20+TT21+TT22+TT30+TT40+TT60 Gasket for glass and ash drawer Ø6mm		<b>09-634</b>
	TT10G Side glass (1 pcs.)	bended	<b>09-404</b>
		straight	<b>09-405</b>
	TT10G Side glass - old model 80mm	bended	<b>09-406</b>
<b>TT20+TT21 spare parts</b> (see detailed drawing)			
	TT10+TT20+TT21 (- Streamline) Form glass plate	glass	<b>30-907</b>
	TT20+TT21+TT10 (-Bazic) Form glass plate (Scandinavian)	glass	<b>30-911</b>
	TT20+TT21+TT10 Fresh air collar (Remember 45-710)	black	<b>09-162</b>

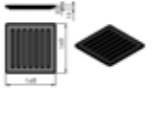
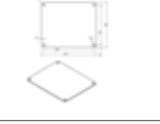

## Spare parts for TT wood-burning stoves

Product	Description	Colour	Item no.
	Direct air connection kit – single connector Contains: Fresh air vent grid, Wall bushing, rosette, insulation, 2 clamps and damper regulation rod	Ø80	<b>45-710</b>
	Direct air connection kit for floor 80/100mm. Contains: 1m. aluflex pipe, 1m. insulation hose, 1 galvanized transition, 2 clamps	Ø80	<b>45-720</b>
	TT20+TT21 Log stopper	black	<b>09-164</b>
	TT20+TT21 Window air flow lip	black	<b>09-166</b>
	TT20+TT21+TT30 Fire tool set for wood compartment	black	<b>09-524</b>
	TT20+TT20R Complete door for wood compartment	black	<b>09-522</b>
		dark grey	<b>09-523</b>
	TT20S+TT20RS+TT20SA Complete door for wood compartment	black	<b>09-526</b>
		dark grey	<b>09-527</b>
	TT20 Streamline R Cover plate for wood compartment	black	<b>09-518</b>
	TT20 Complete door	black	<b>09-810</b>
		dark grey	<b>09-811</b>
	TT1+TT1Z+TT2+TT3+TT10+TT20+TT30 Gasket for doorframe Ø14mm (FD3212W)		<b>09-623</b>
	TT21 Gasket for door Ø12mm (FD3237W)		<b>09-625</b>
	TT1+TT2+TT3+TT10+TT20+TT21+TT22+TT30+TT40+TT60 Gasket for glass and ash drawer Ø6mm		<b>09-634</b>

## Spare parts for TT wood-burning stoves

Product	Description	Colour	Item no.
	TT20+TT21 Glass		<b>09-815</b>
	TT20+TT21 Cast iron bottom without grate		<b>09-820</b>
	TT10+TT20+TT21+TT22+TT30+TT60 Grate for cast iron bottom		<b>09-313</b>
	TT20+TT21 Cover plate for bottom grate		<b>09-824</b>
	TT20+TT40 Round cover plate for steel top	black	<b>09-528</b>
		dark grey	<b>09-529</b>
	TT20 Cast iron frame door		<b>09-822</b>
	TT20+TT22 Complete door handle		<b>09-830</b>
	TT20+TT21+TT22+TT30+TT60 Hinge set incl. B1 spring		<b>09-832</b>
	TT20+TT21 Ash drawer		<b>09-834</b>
	TT20+TT21 Vermiculite complete		<b>09-840</b>
	TT20+TT21 Vermiculite back plate - 1 part		<b>09-841</b>
	TT20+TT21 Vermiculite side plates - 4 parts		<b>09-842</b>

## Spare parts for TT wood-burning stoves

Product	Description	Colour	Item no.
	TT20+TT21 Vermiculite front piece - 1 part or 2 parts		<b>09-843</b>
	TT20+TT21 Vermiculite smoke guide plate		<b>09-844</b>
	TT20 Steel side right (Item with longer delivery time)	black	<b>09-850</b>
		dark grey	<b>09-851</b>
	TT20 Steel side left (Item with longer delivery time)	black	<b>09-852</b>
		dark grey	<b>09-853</b>
	TT20+TT20 Streamline Top plate steel	black	<b>09-858</b>
		dark grey	<b>09-859</b>
	TT20R+TT21R+TT22H Steel side right (Item with longer delivery time)	black	<b>09-854</b>
		dark grey	<b>09-855</b>
	TT20R+TT21R+TT22H Steel side left (Item with longer delivery time)	black	<b>09-856</b>
		dark grey	<b>09-857</b>
	TT20R Top plate steel	black	<b>09-860</b>
		dark grey	<b>09-861</b>
	TT20 Streamline Steel side - black	right	<b>09-862</b>
		left	<b>09-864</b>
	TT20 Streamline R Steel side - black (Item with longer delivery time)	right	<b>09-880</b>
		left	<b>09-882</b>
	TT21R+TT21RL+TT21RH Top plate cast iron without grate (Item with longer delivery time)	black	<b>09-866</b>
	TT21 Complete door (Item with longer delivery time)	black	<b>09-868</b>
		dark grey	<b>09-869</b>











## Spare parts for TT wood-burning stoves

Product	Description	Colour	Item no.
	TT21 Handle complete - standard	rustfri	<b>09-870</b>
	TT21 Handle complete - black	black	<b>09-876</b>
	TT21+TT30 Magnets for door(2 pcs)	black	<b>09-710</b>
		dark grey	<b>09-711</b>
	TT21R+TT21RL+TT21RH Grate for top plate (Item with longer delivery time)	black	<b>09-872</b>
	TT21R+TT21RS Complete door for wood compartment	black	<b>09-874</b>
		dark grey	<b>09-875</b>
	TT21R+TT21RL+TT21RH+TT30 Cast iron cover plate round	black	<b>09-728</b>
<b>TT22 spare parts</b> (see detailed drawing)			
	TT22 Form glass plate	glass	<b>30-910</b>
	TT22 Fresh air collar Ø100 (Remember 45-712)	black	<b>09-552</b>
	Direct air connection kit – single connector Contains: Fresh air vent grid, Wall bushing, rosette, insulation, 2 clamps and damper regulation rod	Ø100	<b>45-712</b>
	TT22 Top plate steel without grate	black	<b>09-558</b>
		dark grey	<b>09-559</b>
	TT22H+TT22R+TT22RP Top plate cast iron without grate	black	<b>09-590</b>
		dark grey	<b>09-591</b>

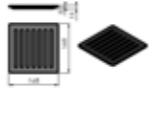
## Spare parts for TT wood-burning stoves

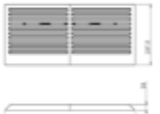
Product	Description	Colour	Item no.
	TT22 Grate for top plate	black	<b>09-576</b>
		dark grey	<b>09-577</b>
	TT22H+TT22R+TT22RP Grate for top plate	black	<b>09-592</b>
		dark grey	<b>09-593</b>
	TT22 Steel side right (seen from the front)	black	<b>09-566</b>
		dark grey	<b>09-567</b>
	TT22 Steel side left (seen from the front)	black	<b>09-568</b>
		dark grey	<b>09-569</b>
	TT22RP Steel side black (Item with longer delivery time)	right	<b>09-580</b>
		left	<b>09-582</b>
	TT20R+TT21R+TT22H Steel side right (seen from the front)	black	<b>09-854</b>
		dark grey	<b>09-855</b>
	TT20R+TT21R+TT22H Steel side left (seen from the front)	black	<b>09-856</b>
		dark grey	<b>09-857</b>
	TT22 Ash drawer		<b>09-550</b>
	TT22 Glass for door		<b>09-554</b>
	TT1+TT2+TT3+TT10+TT20+TT21+TT22+ TT30+TT40+TT60 Gasket for glass and ash drawer Ø6mm		<b>09-634</b>
	TT22 Complete door	black	<b>09-562</b>
		dark grey	<b>09-563</b>
	TT22 Cast iron frame		<b>09-564</b>

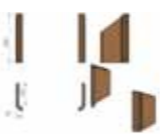
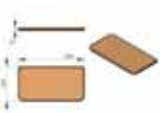









## Spare parts for TT wood-burning stoves

Product	Description	Colour	Item no.
	TT22H+TT22HS Door for wood compartment	black	<b>09-594</b>
		dark grey	<b>09-595</b>
	TT22H+TT22HS+TT30+TT60 Magnet for wood compartment		<b>09-712</b>
	TT22+TT40 Gasket for door Ø12mm (KP250)		<b>09-624</b>
	TT22 Cast iron bottom without grate		<b>09-565</b>
	TT10+TT20+TT21+TT22+TT30+TT60 Grate for cast iron bottom		<b>09-313</b>
	TT22 Vermiculite complete		<b>09-570</b>
	TT22 Vermiculite back 2 parts		<b>09-571</b>
	TT22 Vermiculite front 2 parts		<b>09-572</b>
	TT22 Vermiculite side plates 4 parts		<b>09-573</b>
	TT22 Vermiculite smoke guide plate		<b>09-574</b>
<b>TT30 spare parts</b> (see detailed drawing)			
	TT30 Form glass plate (Scandinavian or EU)	Skandi.	<b>30-908</b>
		EU	<b>30-909</b>
	TT30+TT30G Cast iron top	black	<b>09-724</b>
		dark grey	<b>09-725</b>

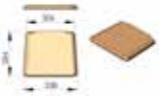



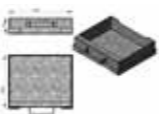





## Spare parts for TT wood-burning stoves

Product	Description	Colour	Item no.
	TT30 Grate for top plate	black	<b>09-726</b>
		dark grey	<b>09-727</b>
	TT30+TT21R+TT21RL+TT21RH Cover plate round for grate	black	<b>09-728</b>
		dark grey	<b>09-729</b>
	TT20+TT21+TT30 Fire tool set for wood compartment	black	<b>09-524</b>
	TT30 Complete door (V1+V2 = Handle straight forward)	black	<b>09-730</b>
		dark grey	<b>09-731</b>
	TT30 Complete door (New model - handle to the side)	black	<b>09-734</b>
		dark grey	<b>09-735</b>
	TT30 Complete door for wood compartment	black	<b>09-732</b>
		dark grey	<b>09-733</b>
	TT30 Cast iron bottom	black	<b>09-722</b>
	TT10+TT20+TT21+TT22+TT30+TT60 Grate for cast iron bottom		<b>09-313</b>
	TT30 Glass		<b>09-700</b>
	TT30G+TT30GS Sideglass right/left		<b>09-701</b>
	TT30 Handle for door incl. screws for V1+V2		<b>09-702</b>
	TT30 Handle for door incl. screws for new model		<b>09-704</b>







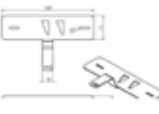



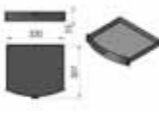

## Spare parts for TT wood-burning stoves

Product	Description	Colour	Item no.
	TT30+TT21 Magnet for door (2 pcs)	black	<b>09-710</b>
		dark grey	<b>09-711</b>
	TT30+TT22H+TT22HS+TT60 Magnet for wood compartment door		<b>09-712</b>
	TT30+TT30S Vermiculite complete		<b>09-713</b>
	TT30G+TT30GS Vermiculite complete		<b>09-714</b>
	TT30 Vermiculite smoke guide plate		<b>09-715</b>
	TT30 Vermiculite back plate		<b>09-716</b>
	TT30 Vermiculite corner set (2 parts)		<b>09-717</b>
	TT30+TT30S Vermiculite side plates set (2 parts)		<b>09-718</b>
	TT30G+TT30GS Vermiculite side plates set (4 parts)		<b>09-719</b>
	TT30 Ash drawer	unpainted	<b>09-740</b>
	TT30 Steel side right (seen from the front)	black	<b>09-742</b>
		dark grey	<b>09-743</b>
	TT30 Steel side left (seen from the front)	black	<b>09-744</b>
		dark grey	<b>09-745</b>











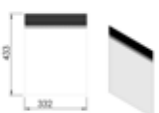

## Spare parts for TT wood-burning stoves

Product	Description	Colour	Item no.
	TT30G Steel side right (seen from the front)	black	<b>09-746</b>
		dark grey	<b>09-747</b>
	TT30G Steel side left (seen from the front)	black	<b>09-748</b>
		dark grey	<b>09-749</b>
	TT1+TT1Z+TT2+TT3+TT10+TT20+TT30 Gasket for doorframe Ø14mm (FD3212W)		<b>09-623</b>
	TT1+TT2+TT3+TT10+TT20+TT21+TT22+ TT30+TT40+TT60 Gasket for glass and ash drawer Ø6mm		<b>09-634</b>
<b>TT40 spare parts</b>			
	TT40 Glass		<b>09-214</b>
	TT40 Complete door	black	<b>09-500</b>
		dark grey	<b>09-501</b>
	TT40 Cast iron bottom		<b>09-503</b>
	TT40 Log stopper - cast iron		<b>09-505</b>
	TT40 Door handle and screw set		<b>09-504</b>
	TT40 Screw set for door handle		<b>09-502</b>
	TT40 Repair kit for door handle Contains: instruction, Ø6mm bushing, tapper, brass disc, 2x spring discs, Ø5mm pinol screw, 6x2mm bolts		<b>09-508</b>
	TT40 Secondary air part and handle	black	<b>09-546</b>
		dark grey	<b>09-547</b>

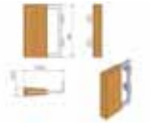





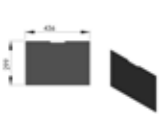

## Spare parts for TT wood-burning stoves

Product	Description	Colour	Item no.
	TT40 Ash drawer	black	<b>09-506</b>
	TT40 Complete door for wood compartment	black	<b>09-520</b>
		dark grey	<b>09-521</b>
	TT40 Vermiculite complete		<b>09-530</b>
	TT40 Vermiculite smoke guide plate  * As long as stock is available		<b>09-532</b>
	TT40 Vermiculite back plate  * As long as stock is available		<b>09-534</b>
	TT40 Vermiculite side plates  * As long as stock is available		<b>09-538</b>
	TT40 Smoke guide plate steel		<b>09-536</b>
	TT40 Top plate steel	black	<b>09-542</b>
		dark grey	<b>09-543</b>
	TT40R Top plate steel	black	<b>09-544</b>
		dark grey	<b>09-545</b>
	TT40+TT22 Gasket for door Ø12mm (KP250)		<b>09-624</b>
	TT40 Gasket set (door Ø12mm, glass Ø6mm)		<b>09-662</b>
	TT1+TT2+TT3+TT10+TT20+TT21+TT22+ TT30+TT40+TT60 Gasket for glass and ash drawer Ø6mm		<b>09-634</b>









## Spare parts for TT wood-burning stoves

Product	Description	Colour	Item no.
	<b>TT60 spare parts</b>		
	Form glass plate – TT60 series – Scandinavia See measure on the web. Cannot be used for corner installation	glass	<b>30-912</b>
	Form glass plate – TT60 series – EU ex. Scandinavia See measure on the web. Cannot be used for corner installation		<b>30-913</b>
	Fresh air collar – backward		<b>09-696</b>
	TT60W+TT60+TT60S Fresh air collar – downward		<b>09-698</b>
	TT60 Glass		<b>09-600</b>
	TT60 Complete door	black	<b>09-676</b>
	TT60 Door handle and screw set	black	<b>09-602</b>
		eg	<b>09-603</b>
	TT60 Magnets (2 pcs)	black	<b>09-708</b>
	TT30+TT22H+TT22HS+TT60 Magnet for wood compartment door		<b>09-712</b>
	TT60 Cast iron bottom		<b>09-674</b>
	TT60 Ash drawer	black	<b>09-650</b>
	TT60 Steel side (fits both sides)	black	<b>09-678</b>
	TT60 Complete door for wood compartment	black	<b>09-688</b>

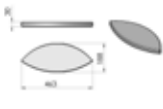
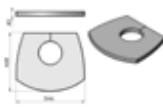
## Spare parts for TT wood-burning stoves

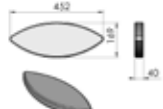
Product	Description	Colour	Item no.
	TT60 Top plate steel	black	<b>09-682</b>
	TT60 Vermiculite complete (4 parts)		<b>09-670</b>
	TT60 Vermiculite smoke guide plate		<b>09-671</b>
	TT60 Vermiculite back plate (1 part)		<b>09-672</b>
	TT60 Vermiculite side plates (2 parts)		<b>09-673</b>
	TT60 Gasket for door 15x8mm (FD3301W)		<b>09-636</b>
	TT1+TT2+TT3+TT10+TT20+TT21+TT22+ TT30+TT40+TT60 Gasket for glass and ash drawer Ø6mm		<b>09-634</b>
	<b>Part various stoves</b>		
	Direct air connection kit – single connector Contains: Fresh air vent grid, Wall bushing, rosette, insulation, 2 clamps and damper regulation rod	Ø80	<b>45-710</b>
		Ø100	<b>45-712</b>
	Universal collar with bolts	black	<b>09-904</b>
		light grey	<b>09-905</b>
	Gasket for collar 60 cm (8*3mm with adhesive)		<b>09-910</b>
	Rubber feet for stove (4 pcs)	black	<b>09-912</b>

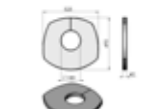
## Spare parts for TT wood-burning stoves

Product	Description	Colour	Item no.
	<b>Spare parts for soapstone</b>		
	Rep-kit for soapstone Contains: Melamine sponge, 2 x "000" steel wool, 2 x "120 Sandpaper", 2 x "220" sandpaper and instruction		<b>08-290</b>
	TT3+TT3H Soapstone top plate  * As long as stock is available	open  closed	<b>08-300</b>  <b>08-301</b>
	TT3H+HS Soapstone cooking unit  * As long as stock is available		<b>08-310</b>
	TT3HS Soapstone side  * As long as stock is available	right  left	<b>08-392</b>  <b>08-393</b>
	TT3S Soapstone top plate  * As long as stock is available	open	<b>08-380</b>
	TT3S Soapstone side  * As long as stock is available	right  left	<b>08-382</b>  <b>08-383</b>
	TT3S+TT3HS+TT10S+TT10HS Soapstone round top Ø172x40mm  * As long as stock is available		<b>08-399</b>
	TT10+TT10H Soapstone top plate  * As long as stock is available	closed	<b>08-303</b>
	TT10H+HS Soapstone cooking unit  * As long as stock is available		<b>08-311</b>
	TT10HS Soapstone side (fits both sides)		<b>08-398</b>
	TT10S+TT10HS Soapstone top plate	open	<b>08-388</b>
	TT10S+TT10HS Soapstone top plate	closed	<b>08-390</b>

Soapstone are always sent on pallets even if the weight is low.

## Spare parts for TT wood-burning stoves

Product	Description	Colour	Item no.
	TT10S Soapstone side (fits both sides)		<b>08-389</b>
	TT20S Soapstone top plate (approx. until 2012) * As long as stock is available	closed	<b>08-401</b>
	TT20SA Sandstone top - old		<b>08-419</b>
	TT20SA Sandstone side right or left		<b>08-434</b>
	TT20SA Sandstone top - new		<b>08-436</b>
	TT20SA Insulatoin for sandstone (2 pcs.)		<b>08-437</b>
	TT20RS Soapstone top plate (approx. until 2012) * As long as stock is available	closed	<b>08-403</b>
	TT20S Soapstone top plate open to the backside (approx. fra 2013)		<b>08-404</b>
	TT20RS+TT21RS+TT21RLS+TT21RHS Soapstone top plate with open to the backside (approx. fra 2013)		<b>08-405</b>
	TT20S+TT20RS+TT21RS+TT21RLS+TT21RHS Top grate steel	black  dark grey	<b>08-406</b>  <b>08-407</b>
	TT20S Soapstone side (fits both sides)		<b>08-410</b>
	TT20RS+TT21RS+TT22HS Soapstone side (fits both sides)		<b>08-412</b>



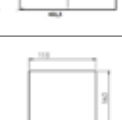

Soapstone are always sent on pallets even if the weight is low.

## Spare parts for TT wood-burning stoves

Product	Description	Colour	Item no.
	TT21RLS Soapstone side (fits both sides)		<b>08-460</b>
	TT21RHS Soapstone side (fits both sides)		<b>08-462</b>
	TT21RS Black Soapstone side, black painted (fits both sides)		<b>08-464</b>
	TT21RS Black Soapstone top, black painted		<b>08-466</b>
	TT20RS+TT21RS+TT21RLS+TT21RHS Soapstone set heat storage		<b>08-422</b>
	TT20RS+TT21RS+TT21RLS+TT21RHS Metal parts for heat storage (Included in 08-422)		<b>08-423</b>
	TT20S+TT20RS+TT21RS Base stone for wood compartment		<b>08-424</b>
	TT20S+TT20RS Fixing part for base stone Prevent base stone from moving backwards in the compartment. (Included in 08-424)		<b>08-429</b>
	TT20RS+TT21RS+TT21RLS+TT21RHS Side stone for heat storage R/L		<b>08-425</b>
	TT20RS+TT21RS+TT21RLS+TT21RHS Front or back stone for heat storage		<b>08-426</b>
	TT20RS+TT21RS+TT21RLS+TT21RHS Center stone for heat storage		<b>08-427</b>
	TT21RHS Base stone for wood compartment		<b>08-446</b>

Soapstone are always sent on pallets even if the weight is low.



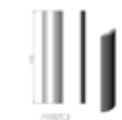
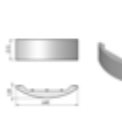







## Spare parts for TT wood-burning stoves

Product	Description	Colour	Item no.
	TT20S+TT20RS+TT20SA+ TT21RS+TT21RLS+TT21RHS Holder for soapstone 2 pcs		<b>08-413</b>
	TT20S+TT20RS+TT20SA+TT21RS+TT21RLS+ TT21RHS+TT22S+TT22HS+TT22 HST Heat plate set		<b>09-556</b>
	TT22S Soapstone side (fits both sides)		<b>08-430</b>
	TT22S Soapstone top plate		<b>08-432</b>
	TT22HS+TT22HST Soapstone top plate open to the backside		<b>08-440</b>
	TT22HS+TT20RS+TT21RS Soapstone side (fits both sides)		<b>08-412</b>
	TT22S+TT22HS Mounting bracket for soapstone side		<b>08-433</b>
	TT22S+TT22HS+TT22HST Grate for top plate	black dark grey	<b>09-560</b> <b>09-561</b>
	TT22HST Soapstone set complete (Included in S01-650 + 651)		<b>08-450</b>
	TT22HST Soapstone side (fits both sides)		<b>08-451</b>
	TT22HST Frontstone for heat storage		<b>08-452</b>
	TT22HST Center stone top for heat storage (1 pcs.)		<b>08-453</b>

Soapstone are always sent on pallets even if the weight is low.

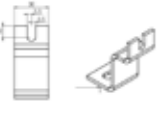



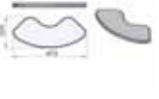

## Spare parts for TT wood-burning stoves

Product	Description	Colour	Item no.
	TT30S+TT30GS Soapstone top		<b>08-500</b>
	TT30S Soapstone side right/left		<b>08-501</b>
	TT30S Nut for top plate 5 pcs.		<b>08-502</b>
	TT30GS Soapstone side (seen from the front)	right	<b>08-503</b>
		left	<b>08-504</b>
	TT40S Soapstone top plate  * As long as stock is available	open	<b>08-394</b>
		closed	<b>08-395</b>
	TT40S Soapstone side (fits both sides)		<b>08-396</b>
	TT40S (TT3S+TT3HS+TT10S+TT10HS) Distance holder for round top stone - universal		<b>08-397</b>
	TT40S Mounting bracket for soapstone		<b>08-370</b>
	TT40S Dowel set		<b>08-372</b>
	TT40S Heat plate set  * As long as stock is available		<b>92-154</b>
	TT40H Soapstone top plate  * As long as stock is available		<b>08-415</b>
	TT40H Soapstone for cooking unit  * As long as stock is available		<b>08-416</b>

Soapstone are always sent on pallets even if the weight is low.

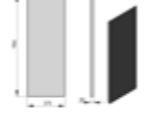
## Spare parts for TT wood-burning stoves

Product	Description	Colour	Item no.
	TT40H Soapstone round top  * As long as stock is available		<b>08-417</b>
	TT60S Soapstone top		<b>08-600</b>
	TT60S Soapstone side right/left		<b>08-602</b>
	TT60S Top grid steel		<b>09-684</b>

Soapstone are always sent on pallets even if the weight is low.

# Type TT20 Streamline

Item No.: 501-606  
Drawing 40906 black

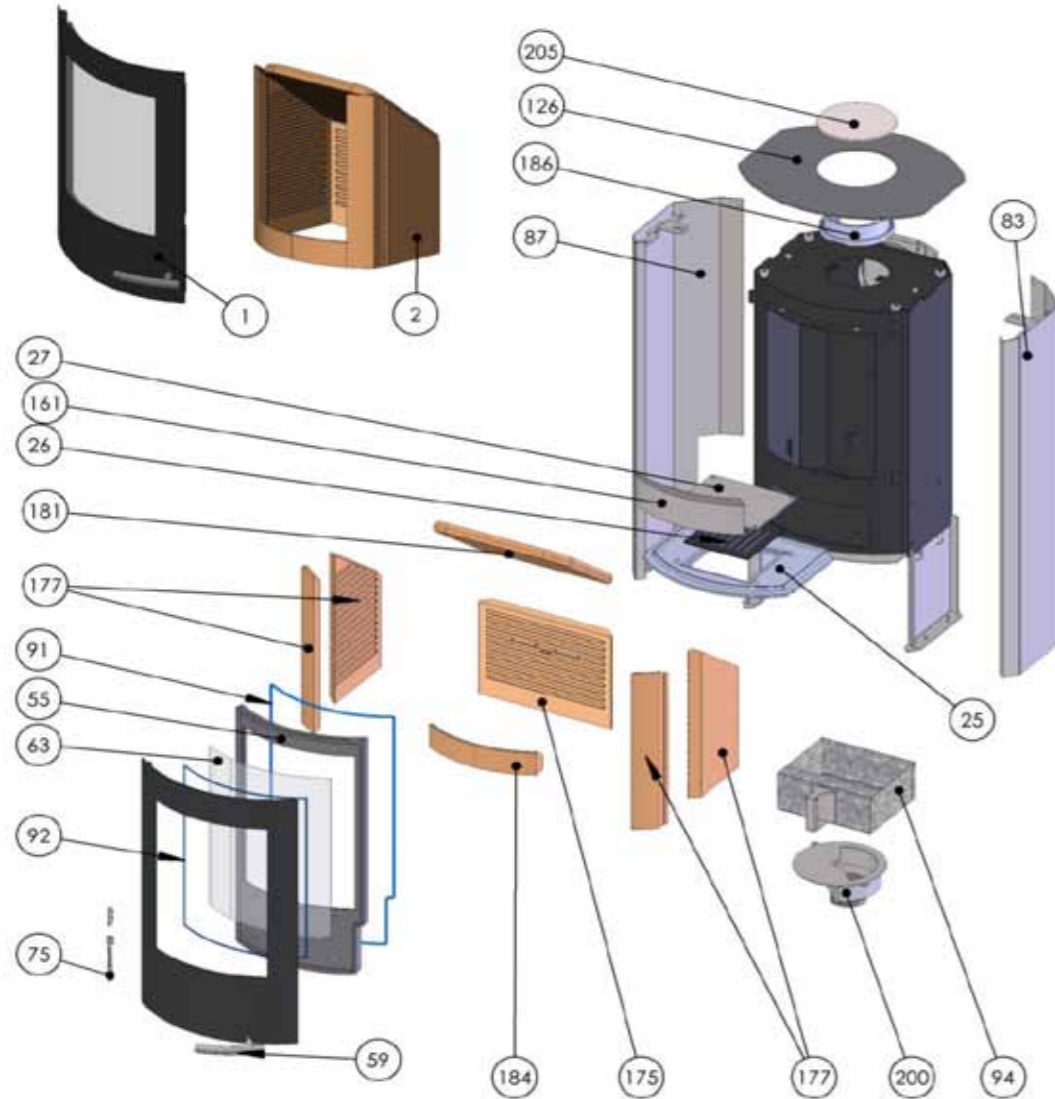

DK: "Dette dokument og indholdet i samme, tilhører TermaTech A/S. Det må ikke kopieres, sælges, distribueres eller på anden måde gengives uden skriftlig tilladelse fra TermaTech A/S."  
 GB: "This document and its content, is the property of TermaTech A/S, and may not be copied, sold or distributed in any form, without prior written consent by TermaTech A/S"  
 DE: "Sämtliche Inhalte dieser Dokumente sind unser Eigentum und gehören ausschließlich TermaTech A/S. Es darf nicht ohne die schriftliche Genehmigung von TermaTech A/S kopiert, verkauft, verteilt oder anderweitig reproduziert werden."

Position no.:	Colour:	Item number:	Position no.:	Colour:	Item number:	Position no.:	Colour:	Item number:
1	black	09-810	126	black	09-858			
2		09-840	161		09-164			
25		09-820	175		09-841			
26		09-313	177		09-842			
27		09-824	181		09-844			
55		09-822	184		09-843			
59		09-830	186	black	09-904			
63		09-815	200	black	09-162			
75		09-832	205	black	09-528			
83	black	09-862						
87	black	09-864						
91		09-623						
92		09-634						
94		09-834						

TermaTech AS Gunnar Clausens Vej 36 DK-8260 Viby J Tlf.: +45 87 42 00 35 Fax: +45 87 42 00 36 info@termatech.com www.termatech.com

# Type TT20 Streamline R

Item No.: 501-608  
Drawing 40907 black

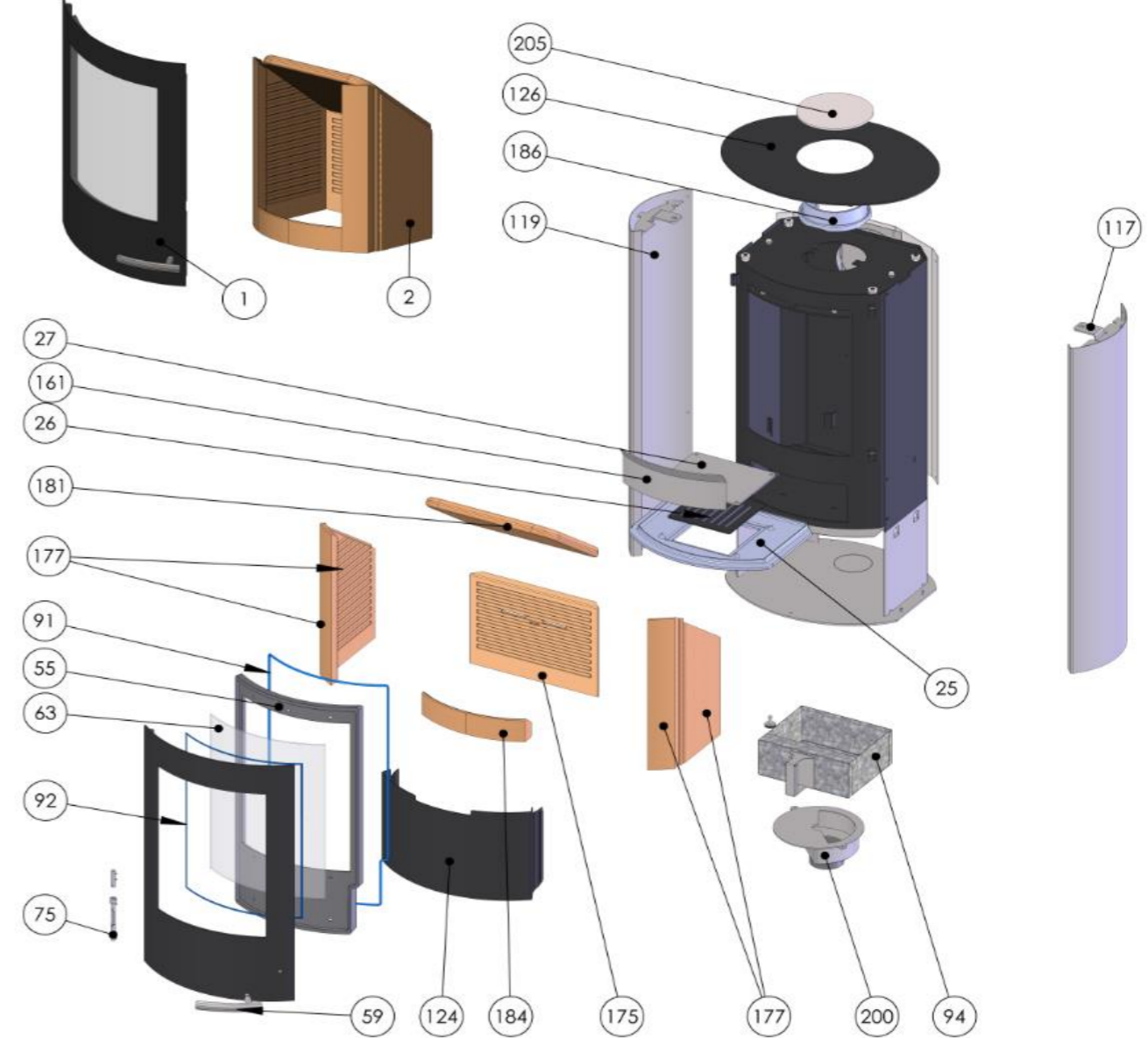

DK: "Dette dokument og indholdet i samme, tilhører TermaTech A/S. Det må ikke kopieres, sælges, distribueres eller på anden måde gengives uden skriftlig tilladelse fra TermaTech A/S."  
 GB: "This document and its content, is the property of TermaTech A/S, and may not be copied, sold or distributed in any form, without prior written consent by TermaTech A/S"  
 DE: "Sämtliche Inhalte dieser Dokumente sind unser Eigentum und gehören ausschließlich TermaTech A/S. Es darf nicht ohne die schriftliche Genehmigung von TermaTech A/S kopiert, verkauft, verteilt oder anderweitig reproduziert werden."  
 FR: "Ce document et son contenu appartient intégralement à TermaTech A/S Il est formellement interdit de le copier, vendre, distribuer ou reproduire sans l'autorisation écrite de TermaTech A/S."

Position no.:	Colour:	Item number:	Position no.:	Colour:	Item number:	Position no.:	Colour:	Item number:
1	black	09-810	117	black	09-880			
2		09-840	119	black	09-882			
25		09-820	124	black	09-518			
26		09-313	126	black	09-860			
27		09-824	161		09-164			
55		09-822	175		09-841			
59		09-830	177		09-842			
63		09-815	181		09-844			
75		09-832	184		09-843			
91		09-623	186	black	09-904			
92		09-634	200	black	09-162			
94		09-834	205	black	09-528			

TermaTech AS Gunnar Clausens Vej 36 DK-8260 Viby J Tlf.: +45 87 42 00 35 Fax: +45 87 42 00 36 info@termatech.com www.termatech.com

# Type TT20

Item No. 501-600 black  
 Item No. 501-601 dark grey  
 Drawing. 40901

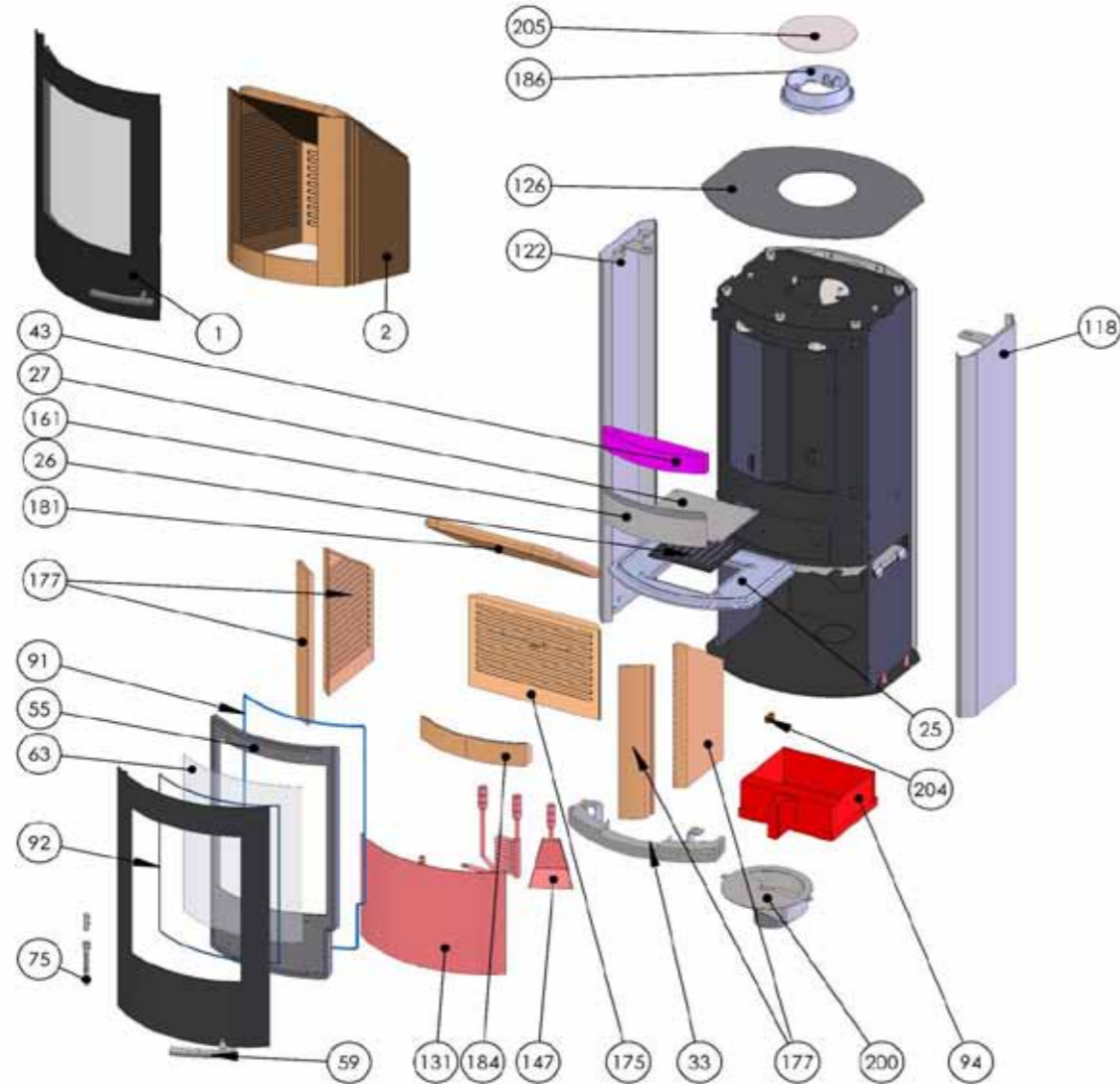

DK: "Dette dokument og indholdet i samme, tilhører TermaTech A/S. Det må ikke kopieres, sælges, distribueres eller på anden måde gengives uden skriftlig tilladelse fra TermaTech A/S."  
 GB: "This document and its content, is the property of TermaTech A/S, and may not be copied, sold or distributed in any form, without prior written consent by TermaTech A/S"  
 DE: "Sämtliche Inhalte dieser Dokumente sind unser Eigentum und gehören ausschließlich TermaTech A/S. Es darf nicht ohne die schriftliche Genehmigung von TermaTech A / S kopiert, verkauft, verteilt oder anderweitig reproduziert werden."

Position no.:	Colour:	Item number:	Position no.:	Colour:	Item number:	Position no.:	Colour:	Item number:
1	black	09-810	118	black	09-850	181		09-844
	dark grey	09-811		dark grey	09-851	184		09-843
2		09-840	122	black	09-852	186	black	09-904
25		09-820		dark grey	09-853		dark grey	09-905
26		09-313	126	black	09-858	200	black	09-162
27		09-824		dark grey	09-859	204		09-836
33		09-160	131	black	09-522	205	black	09-528
43	black	09-166		dark grey	09-523		dark grey	09-529
55		09-822	147		09-524			
59		09-830	161		09-164			
63		09-815	175		09-841			
75		09-832	177		09-842			
91		09-623						
92		09-634						
94		09-834						

# Type TT20S

Item No.: 501-618 black  
 Item No.: 501-619 dark grey  
 Drawing.: 40903

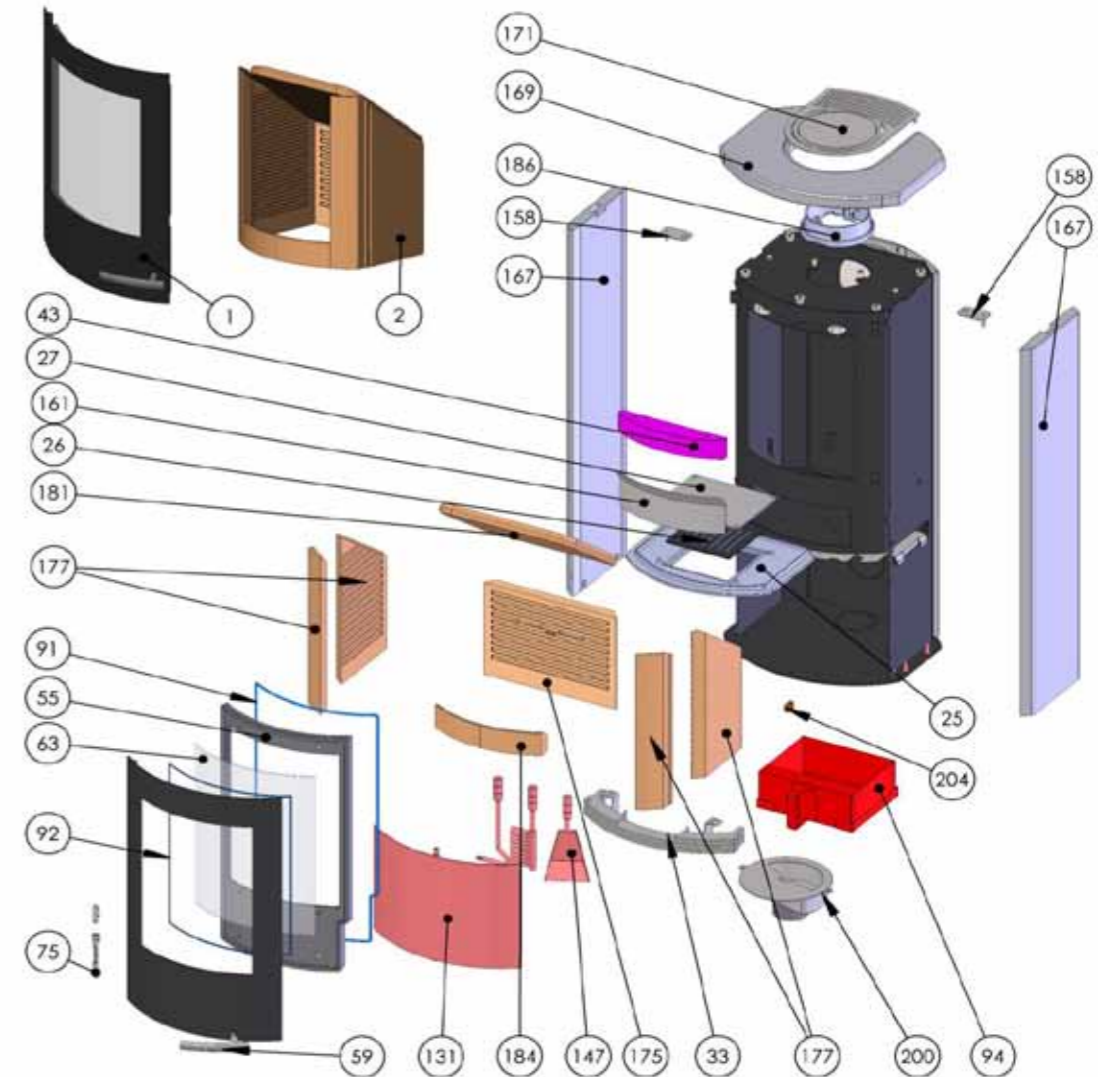

DK: "Dette dokument og indholdet i samme, tilhører TermaTech A/S. Det må ikke kopieres, sælges, distribueres eller på anden måde gengives uden skriftlig tilladelse fra TermaTech A/S."  
 GB: "This document and its content, is the property of TermaTech A/S, and may not be copied, sold or distributed in any form, without prior written consent by TermaTech A/S"  
 DE: "Sämtliche Inhalte dieser Dokumente sind unser Eigentum und gehören ausschließlich TermaTech A/S. Es darf nicht ohne die schriftliche Genehmigung von TermaTech A / S kopiert, verkauft, verteilt oder anderweitig reproduziert werden."

Position no.:	Colour:	Item number:	Position no.:	Colour:	Item number:	Position no.:	Colour:	Item number:
1	black	09-810	131	black	09-526	186	black	09-904
	dark grey	09-811		dark grey	09-527		dark grey	09-905
2		09-840	147		09-524	200	black	09-162
25		09-820	158		08-413			
26		09-313	161		09-164			
27		09-824	167		08-410			
33		09-160	169		08-404			
43	black	09-166	171	black	08-406			
55		09-822		dark grey	08-407			
59		09-830	175		09-841			
63		09-815	177		09-842			
75		09-832	181		09-844			
91		09-623	184		09-843			
92		09-634						
94		09-834						

# Type: TT20R

Item No.: S01-602 black  
 Item No.: S01-603 dark grey  
 Drawing: 40902

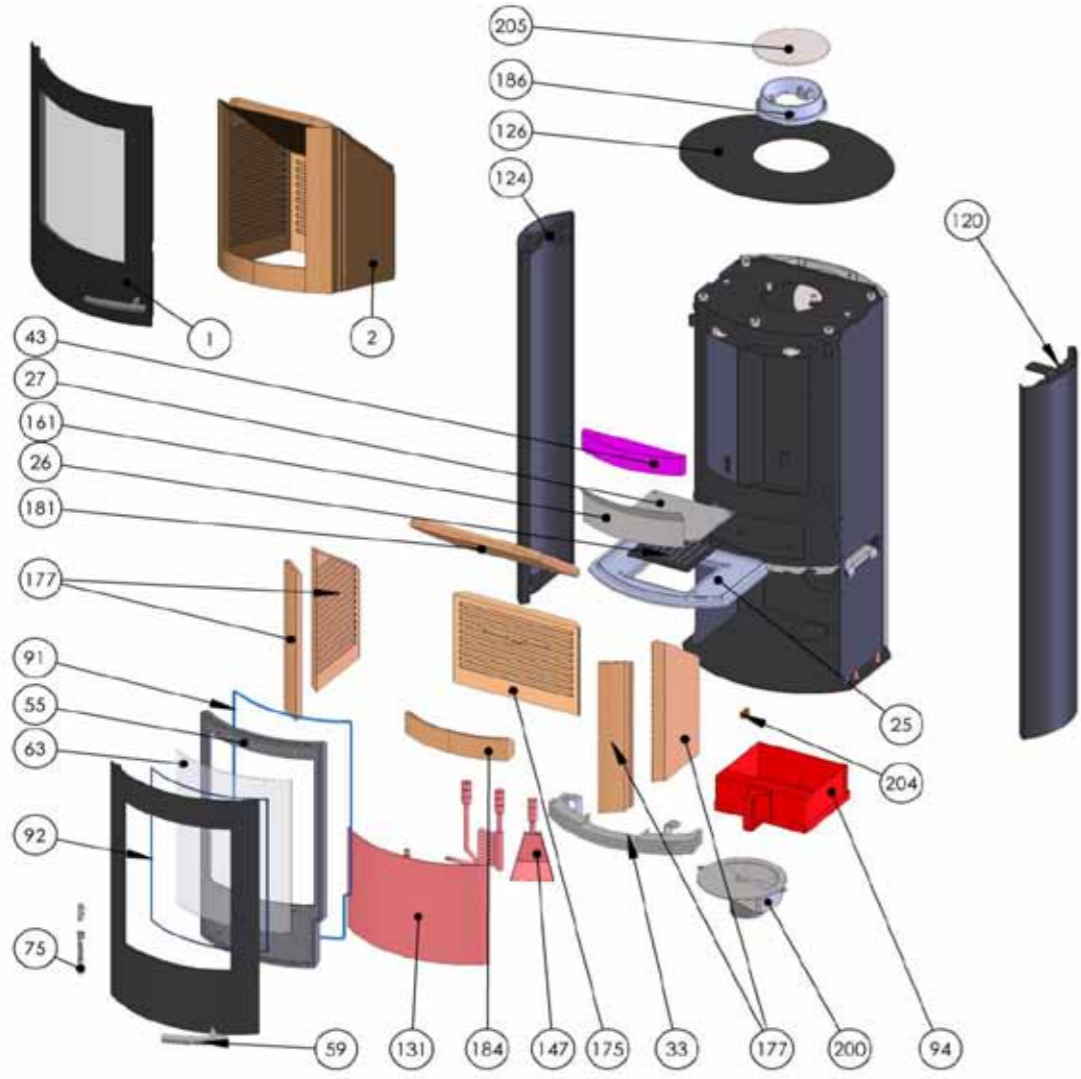

DK: "Dette dokument og indholdet i samme, tilhører TermaTech A/S. Det må ikke kopieres, sælges, distribueres eller på anden måde gengives uden skriftlig tilladelse fra TermaTech A/S."  
 GB: "This document and it's content, is the property of TermaTech A/S, and may not be copied, sold or distributed in any form, without prior written consent by TermaTech A/S"  
 DE: "Sämtliche Inhalte dieser Dokumente sind unser Eigentum und gehören ausschließlich TermaTech A/S. Es darf nicht ohne die schriftliche Genehmigung von TermaTech A / S kopiert, verkauft, verteilt oder anderweitig reproduziert werden."

Position no.:	Colour:	Item number:	Position no.:	Colour:	Item number:	Position no.:	Colour:	Item number:
1	black	09-810	124	black	09-856	200	black	09-162
	dark grey	09-811		dark grey	09-857	204		09-836
2		09-840	126	black	09-860	205	black	09-528
25		09-820		dark grey	09-861		dark grey	09-529
26		09-313	131	black	09-522			
27		09-824		dark grey	09-523			
33		09-160	147		09-524			
43	black	09-166	161		09-164			
55		09-822	175		09-841			
59		09-830	177		09-842			
63		09-815	181		09-844			
75		09-832	184		09-843			
91		09-623	186	black	09-904			
92		09-634		dark grey	09-905			
94		09-834						
120	black	09-854						
	dark grey	09-855						

TermaTech AS Gunnar Clausens Vej 36 DK-8260 Viby J Tlf.: +45 87 42 00 35 Fax: +45 87 42 00 36 info@termatech.com www.termatech.com

# Type TT20RS

Item No.: S01-620 black  
 Item No.: S01-621 dark grey  
 Drawing: 40904

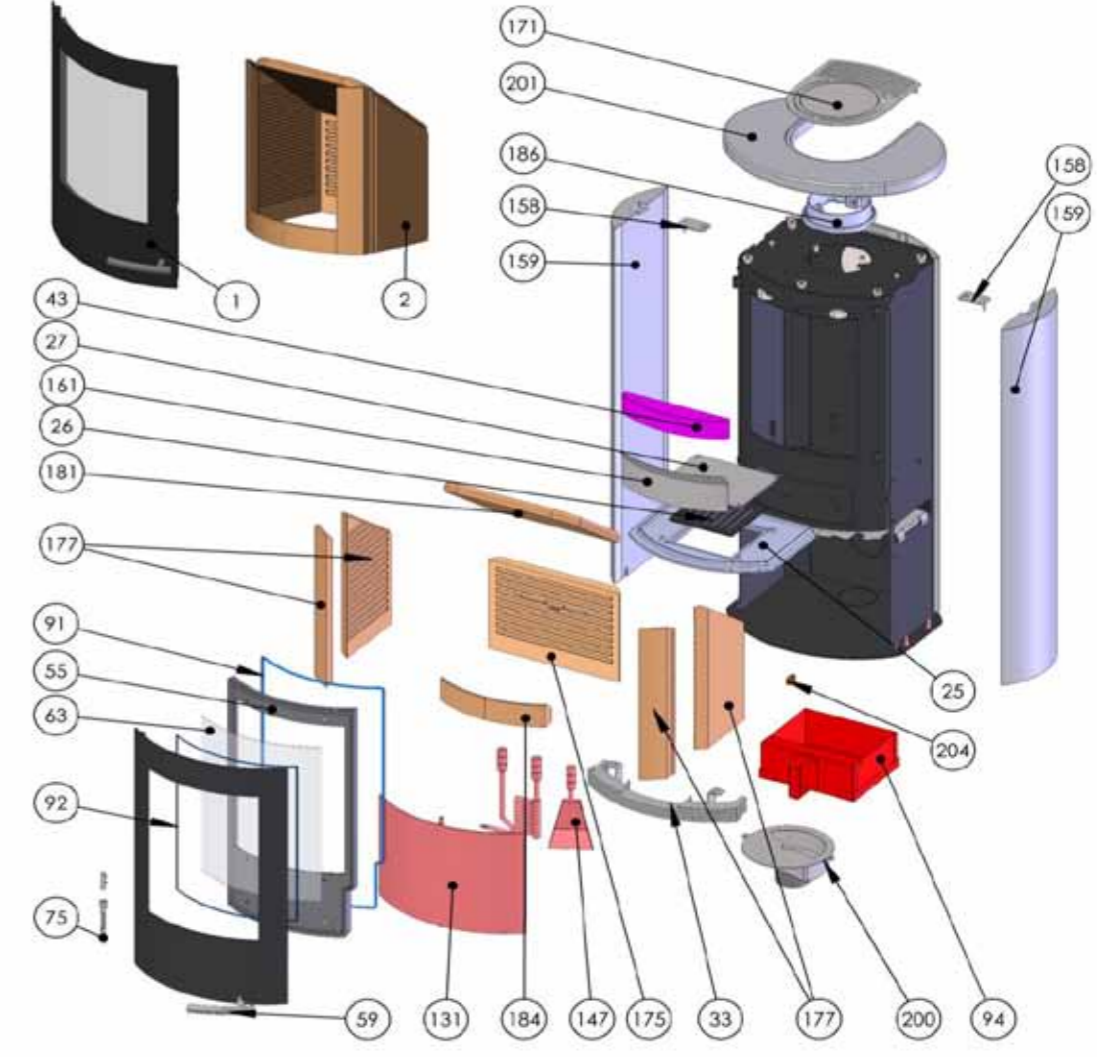

DK: "Dette dokument og indholdet i samme, tilhører TermaTech A/S. Det må ikke kopieres, sælges, distribueres eller på anden måde gengives uden skriftlig tilladelse fra TermaTech A/S."  
 GB: "This document and it's content, is the property of TermaTech A/S, and may not be copied, sold or distributed in any form, without prior written consent by TermaTech A/S"  
 DE: "Sämtliche Inhalte dieser Dokumente sind unser Eigentum und gehören ausschließlich TermaTech A/S. Es darf nicht ohne die schriftliche Genehmigung von TermaTech A / S kopiert, verkauft, verteilt oder anderweitig reproduziert werden."

Position no.:	Colour:	Item number:	Position no.:	Colour:	Item number:	Position no.:	Colour:	Item number:
1	black	09-810	147		09-524	200	black	09-162
	dark grey	09-811	158		08-413	204		09-836
2		09-840	159		08-412			
25		09-820	161		09-164			
26		09-313	171	black	08-406			
27		09-824		dark grey	08-407			
33		09-160	175		09-841			
43	black	09-166	177		09-842			
55		09-822	181		09-844			
59		09-830	184		09-843			
63		09-815	186	black	09-904			
75		09-832		dark grey	09-905			
91		09-623	201		08-405			
92		09-634						
94		09-834						
131	black	09-522						
	dark grey	09-523						

TermaTech AS Gunnar Clausens Vej 36 DK-8260 Viby J Tlf.: +45 87 42 00 35 Fax: +45 87 42 00 36 info@termatech.com www.termatech.com

# Type TT20SA

Item No.: S01-626  
Drawing.: No number

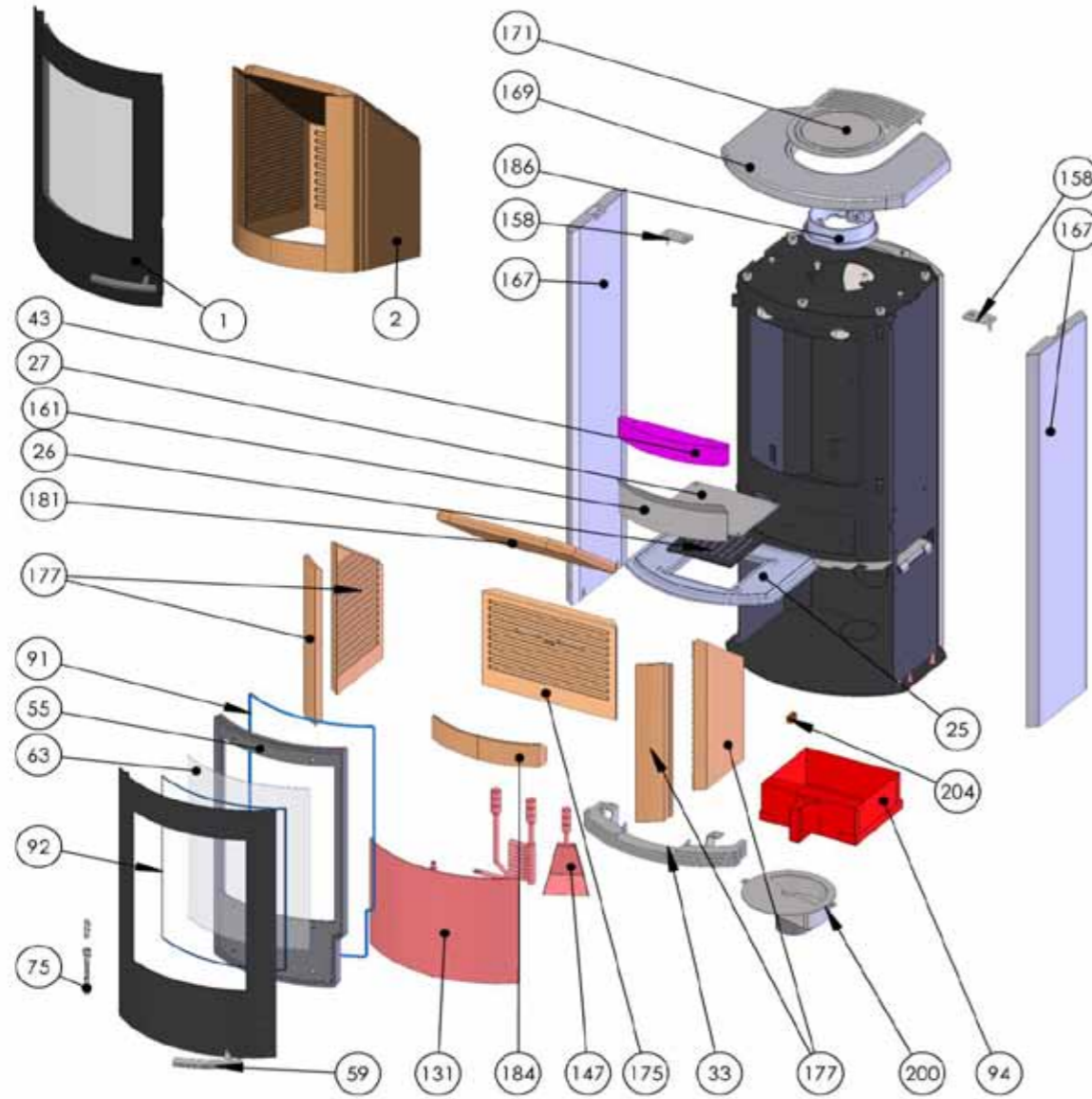

DK: "Dette dokument og indholdet i samme, tilhører TermaTech A/S. Det må ikke kopieres, sælges, distribueres eller på anden måde gengives uden skriftlig tilladelse fra TermaTech A/S."  
GB: "This document and its content, is the property of TermaTech A/S, and may not be copied, sold or distributed in any form, without prior written consent by TermaTech A/S"  
DE: "Sämtliche Inhalte dieser Dokumente sind unser Eigentum und gehören ausschließlich TermaTech A/S. Es darf nicht ohne die schriftliche Genehmigung von TermaTech A / S kopiert, verkauft, verteilt oder anderweitig reproduziert werden."

Position no.:	Colour:	Item number:	Position no.:	Colour:	Item number:	Position no.:	Colour:	Item number:
1		09-810	131		09-526			
2		09-840	147		09-524			
25		09-820	158		08-413			
26		09-313	161		09-164			
27		09-824	167		08-434			
33		09-160	169		08-436			
43		09-166	171		08-406			
55		09-822	175		09-841			
59		09-830	177		09-842			
63		09-815	181		09-844			
75		09-832	184		09-843			
91		09-623	186		09-904			
92		09-634	200		09-162			
94		09-834						

# Type TT20HST

Item No.: S01-620  
Item No.: S01-621  
Drawing.: 40905  
Black  
Dark grey

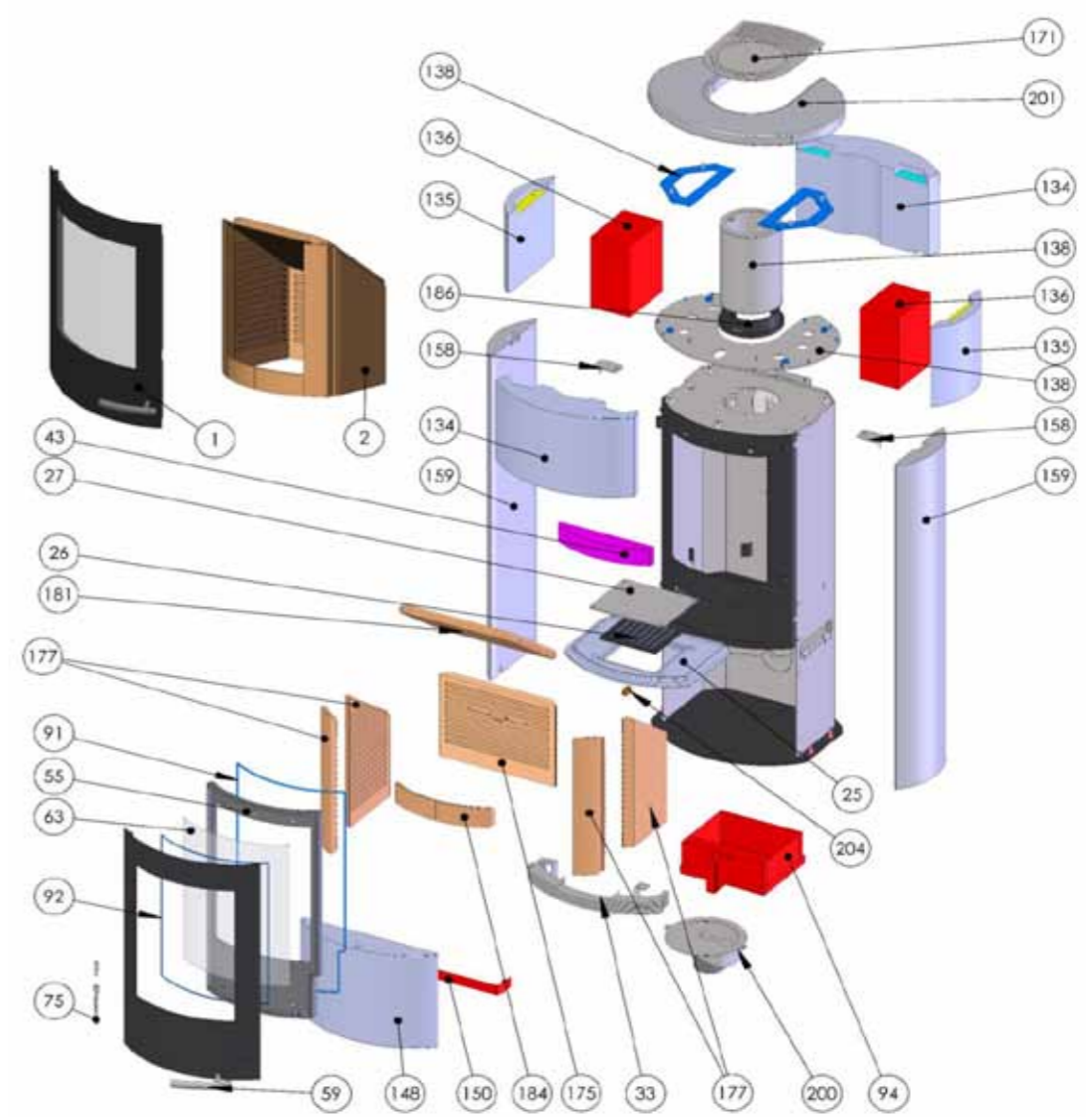

DK: "Dette dokument og indholdet i samme, tilhører TermaTech A/S. Det må ikke kopieres, sælges, distribueres eller på anden måde gengives uden skriftlig tilladelse fra TermaTech A/S."  
GB: "This document and its content, is the property of TermaTech A/S, and may not be copied, sold or distributed in any form, without prior written consent by TermaTech A/S"  
DE: "Sämtliche Inhalte dieser Dokumente sind unser Eigentum und gehören ausschließlich TermaTech A/S. Es darf nicht ohne die schriftliche Genehmigung von TermaTech A / S kopiert, verkauft, verteilt oder anderweitig reproduziert werden."

Position no.:	Colour:	Item number:	Position no.:	Colour:	Item number:	Position no.:	Colour:	Item number:
1	black	09-810	134		08-426	184		09-843
	dark grey	09-811	135		08-425			
2		09-840	136		08-427	186	black	09-904
25		09-820	138		08-423		dark grey	09-905
26		09-313	147		09-524			
27		09-824	148		08-424	201		08-405
33		09-160	158		08-413	200	black	09-162
43	black	09-166	159		08-412	204		09-836
55		09-822	161		09-164			
59		09-830	171	black	08-406			
63		09-815		dark grey	08-407			
75		09-832	175		09-841			
91		09-623	177		09-842			
92		09-634	181		09-844			
94		09-834						

# Type: TT21R

Item No.: S01-630 black  
Drawing: 40908

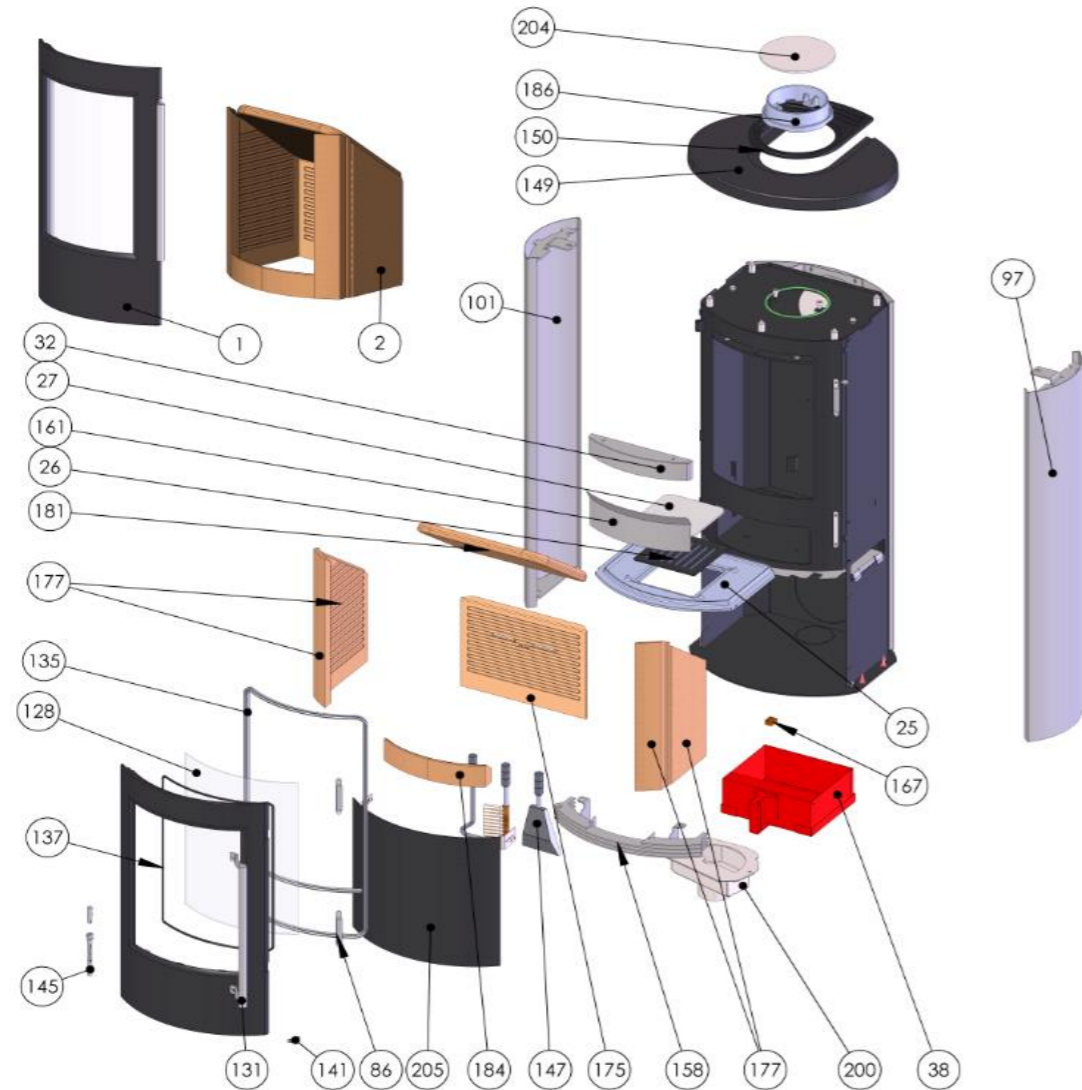

DK: "Dette dokument og indholdet i samme, tilhører TermaTech A/S. Det må ikke kopieres, sælges, distribueres eller på anden måde gengives uden skriftlig tilladelse fra TermaTech A/S."  
 GB: "This document and its content, is the property of TermaTech A/S, and may not be copied, sold or distributed in any form, without prior written consent by TermaTech A/S"  
 DE: "Sämtliche Inhalte dieser Dokumente sind unser Eigentum und gehören ausschließlich TermaTech A/S. Es darf nicht ohne die schriftliche Genehmigung von TermaTech A/S kopiert, verkauft, verteilt oder anderweitig reproduziert werden."  
 FR: "Ce document et son contenu appartient intégralement à TermaTech A/S Il est formellement interdit de le copier, vendre, distribuer ou reproduire sans l'autorisation écrite de TermaTech A/S."

Position no.:	Colour:	Item number:	Position no.:	Colour:	Item number:	Position no.:	Colour:	Item number:
1	black	09-868	158		9999			
2		09-840	161		09-164			
25		09-820	167		09-836			
26		09-313	175		09-841			
27		09-824	177		09-842			
33	black	09-166	181		09-844			
38		09-834	184		09-843			
86	black	09-710	186	black	09-904			
97	black	09-854	200	black	09-162			
101	black	09-856	204	black	09-728			
128		09-815	205	black	09-874			
131		09-870						
135		09-625						
137		09-634						
141		9999						
145		09-832						
147		09-524						
149	black	09-866						
150	black	09-872						

# Type: TT21RS

Item No.: S01-632 black  
S01-633 grey  
Drawing: 40909

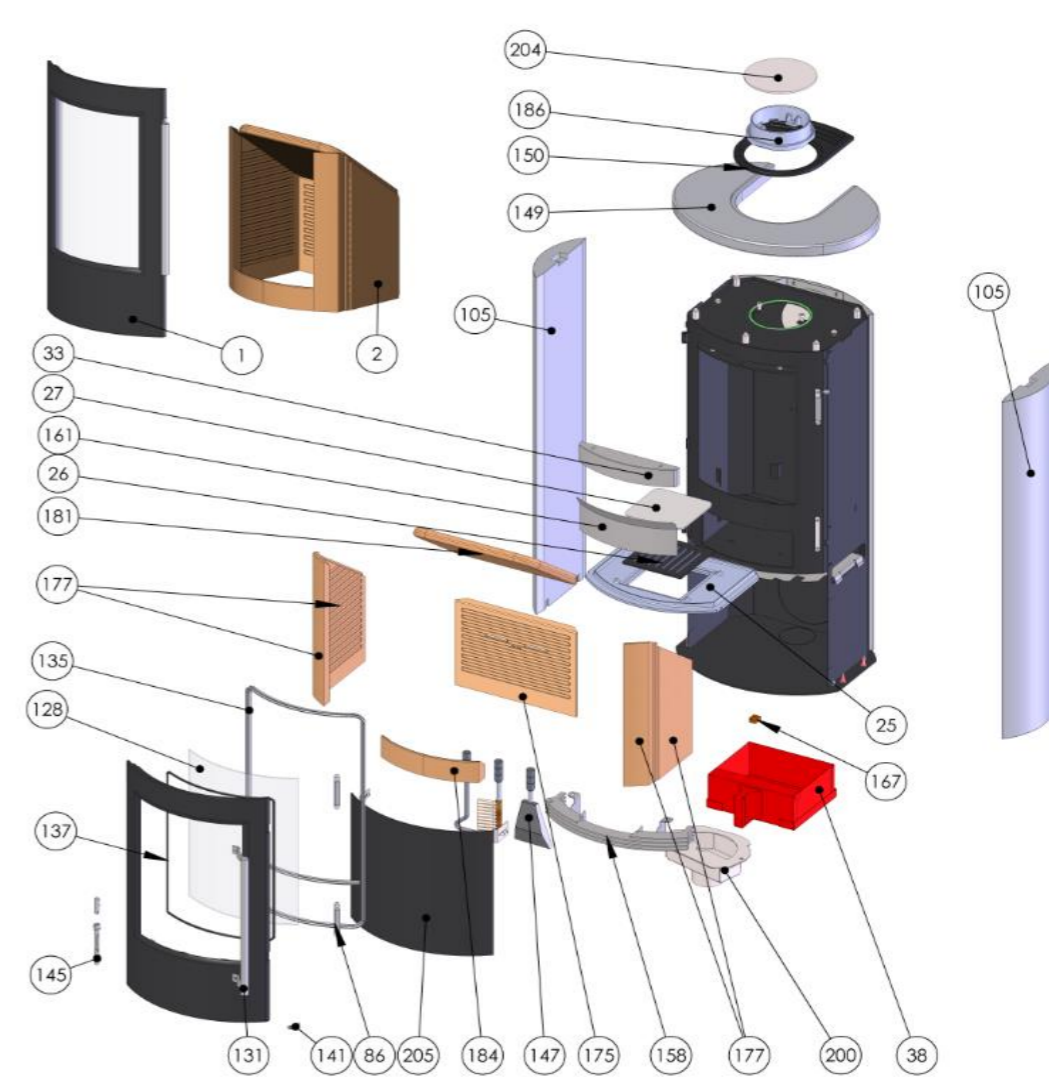

DK: "Dette dokument og indholdet i samme, tilhører TermaTech A/S. Det må ikke kopieres, sælges, distribueres eller på anden måde gengives uden skriftlig tilladelse fra TermaTech A/S."  
 GB: "This document and its content, is the property of TermaTech A/S, and may not be copied, sold or distributed in any form, without prior written consent by TermaTech A/S"  
 DE: "Sämtliche Inhalte dieser Dokumente sind unser Eigentum und gehören ausschließlich TermaTech A/S. Es darf nicht ohne die schriftliche Genehmigung von TermaTech A/S kopiert, verkauft, verteilt oder anderweitig reproduziert werden."  
 FR: "Ce document et son contenu appartient intégralement à TermaTech A/S Il est formellement interdit de le copier, vendre, distribuer ou reproduire sans l'autorisation écrite de TermaTech A/S."

Position no.:	Colour:	Item number:	Position no.:	Colour:	Item number:	Position no.:	Colour:	Item number:
1	black	09-868	145		09-832			
	grey	09-869	147		09-524			
2		09-840	149		08-405			
25		09-820						
26		09-313	150	black	08-406			
27		09-824		grey	08-407			
33	black	09-166						
38		09-834	158		9999			
			161		09-164			
86	black	09-710	167		09-836			
	grey	09-711	175		09-841			
			177		09-842			
105		08-412	181		09-844			
128		09-815	184		09-843			
131		09-870	186	black	09-904			
135		09-625	200	black	09-162			
137		09-634						
141		9999	205	black	09-874			
				grey	09-875			

# Type: TT21RS Black

Item No.: S01-624 black  
Drawing: 40910

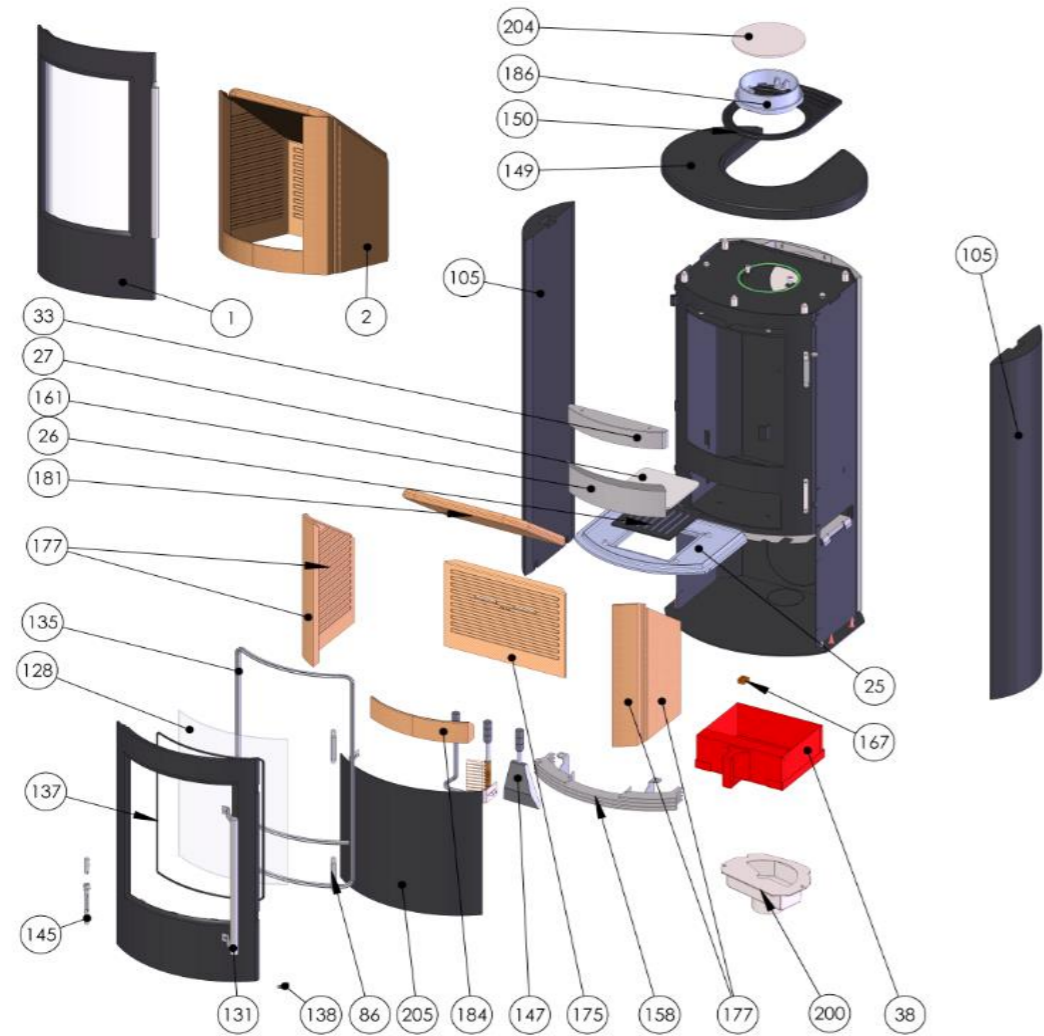

DK: "Dette dokument og indholdet i samme, tilhører TermaTech A/S. Det må ikke kopieres, sælges, distribueres eller på anden måde gengives uden skriftlig tilladelse fra TermaTech A/S."  
 GB: "This document and its content, is the property of TermaTech A/S, and may not be copied, sold or distributed in any form, without prior written consent by TermaTech A/S"  
 DE: "Sämtliche Inhalte dieser Dokumente sind unser Eigentum und gehören ausschließlich TermaTech A/S. Es darf nicht ohne die schriftliche Genehmigung von TermaTech A / S kopiert, verkauft, verteilt oder anderweitig reproduziert werden."  
 FR: "Ce document et son contenu appartient intégralement à TermaTech A/S Il est formellement interdit de le copier, vendre, distribuer ou reproduire sans l'autorisation écrite de TermaTech A/S. »

Position no.:	Colour:	Item number:	Position no.:	Colour:	Item number:	Position no.:	Colour:	Item number:
1	black	09-868	158		9999			
2		09-840	161		09-164			
25		09-820	167		09-836			
26		09-313	175		09-841			
27		09-824	177		09-842			
33	black	09-166	181		09-844			
38		09-834	184		09-843			
86		09-710	186	black	09-904			
105	black	08-464	200	black	09-162			
128		09-815	204		08-406			
131		09-870	205		09-874			
135		09-625						
137		09-634						
138		9999						
145		09-832						
147		09-524						
149	black	08-466						
150	black	08-406						

# Type: TT21RL

Item No.: S01-628 black  
Drawing: 40911

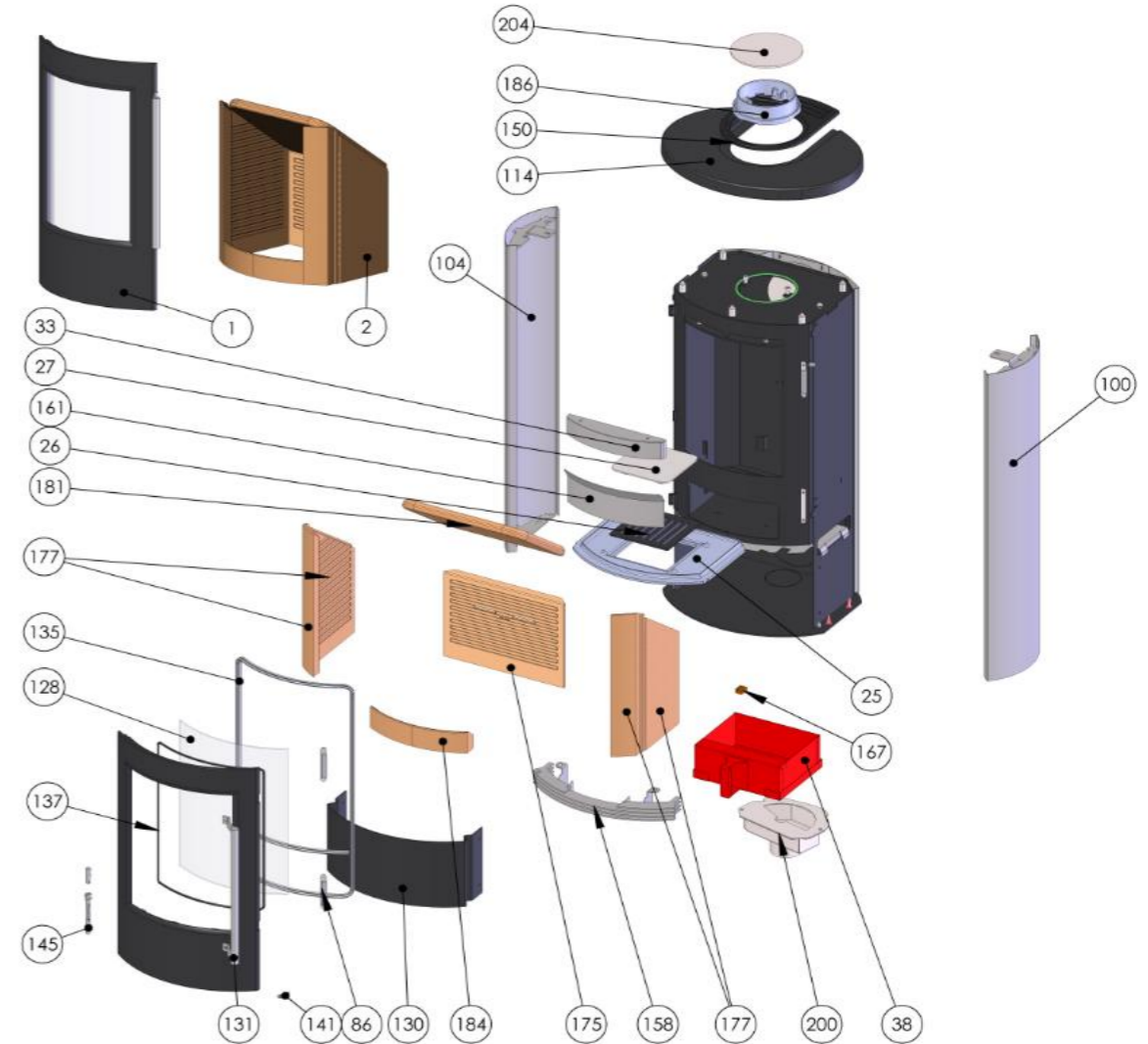

DK: "Dette dokument og indholdet i samme, tilhører TermaTech A/S. Det må ikke kopieres, sælges, distribueres eller på anden måde gengives uden skriftlig tilladelse fra TermaTech A/S."  
 GB: "This document and its content, is the property of TermaTech A/S, and may not be copied, sold or distributed in any form, without prior written consent by TermaTech A/S"  
 DE: "Sämtliche Inhalte dieser Dokumente sind unser Eigentum und gehören ausschließlich TermaTech A/S. Es darf nicht ohne die schriftliche Genehmigung von TermaTech A / S kopiert, verkauft, verteilt oder anderweitig reproduziert werden."  
 FR: "Ce document et son contenu appartient intégralement à TermaTech A/S Il est formellement interdit de le copier, vendre, distribuer ou reproduire sans l'autorisation écrite de TermaTech A/S. »

Position no.:	Colour:	Item number:	Position no.:	Colour:	Item number:	Position no.:	Colour:	Item number:
1	black	09-868	158		9999			
2		09-840	161		09-164			
25		09-820	167		09-836			
26		09-313	175		09-841			
27		09-824	177		09-842			
33	black	09-166	181		09-844			
38		09-834	184		09-843			
86	black	09-710	186	black	09-904			
100	black	9999	200	black	09-162			
104	black	9999	204		09-728			
114	black	09-866						
128		09-815						
130		9999						
131		09-870						
135		09-625						
137		09-634						
141		9999						
145		09-832						
150	black	09-872						

# Type: TT21RLS

Item No.: S01-634 black  
Drawing: 40912

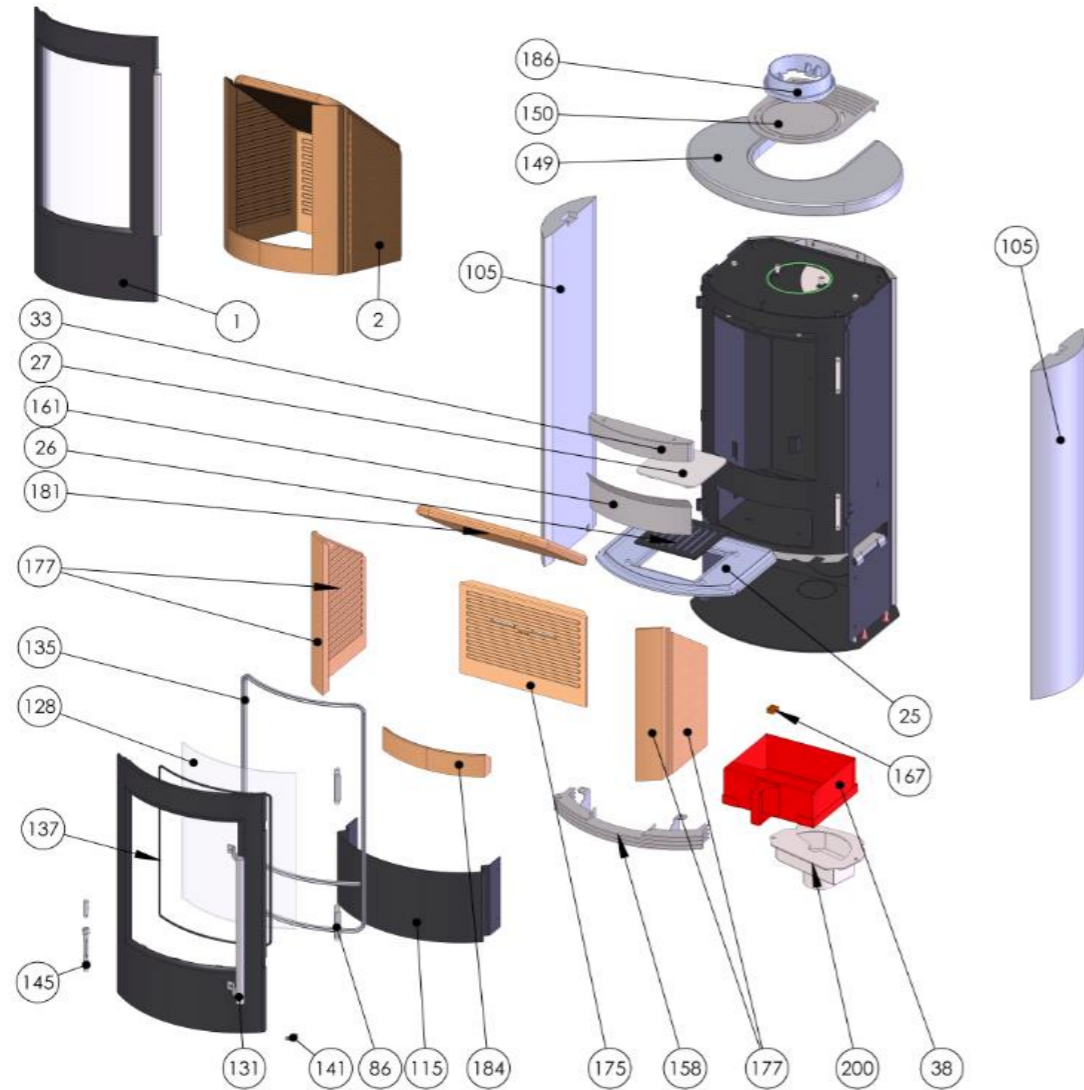

DK: "Dette dokument og indholdet i samme, tilhører TermaTech A/S. Det må ikke kopieres, sælges, distribueres eller på anden måde gengives uden skriftlig tilladelse fra TermaTech A/S."

GB: "This document and its content, is the property of TermaTech A/S, and may not be copied, sold or distributed in any form, without prior written consent by TermaTech A/S"

DE: "Sämtliche Inhalte dieser Dokumente sind unser Eigentum und gehören ausschließlich TermaTech A/S. Es darf nicht ohne die schriftliche Genehmigung von TermaTech A/S kopiert, verkauft, verteilt oder anderweitig reproduziert werden."

FR: "Ce document et son contenu appartient intégralement à TermaTech A/S Il est formellement interdit de le copier, vendre, distribuer ou reproduire sans l'autorisation écrite de TermaTech A/S."

Position no.:	Colour:	Item number:	Position no.:	Colour:	Item number:	Position no.:	Colour:	Item number:
1		09-868	158		9999			
2		09-840	161		09-164			
25		09-820	167		09-836			
26		09-313	175		09-841			
27		09-824	177		09-842			
33		09-166	181		09-844			
38		09-834	184		09-843			
86		09-710	186		09-904			
105		08-460	200		09-162			
115		9999						
128		09-815						
131		09-870						
135		09-625						
137		09-634						
141		9999						
145		09-832						
149		08-405						
150		08-406						

TermaTech AS Gunnar Clausens Vej 36 DK-8260 Viby J Tlf.: +45 87 42 00 35 Fax: +45 87 42 00 36 info@termatech.com www.termatech.com

# Type: TT21RH

Item No.: S01-636 black  
Drawing: 40913

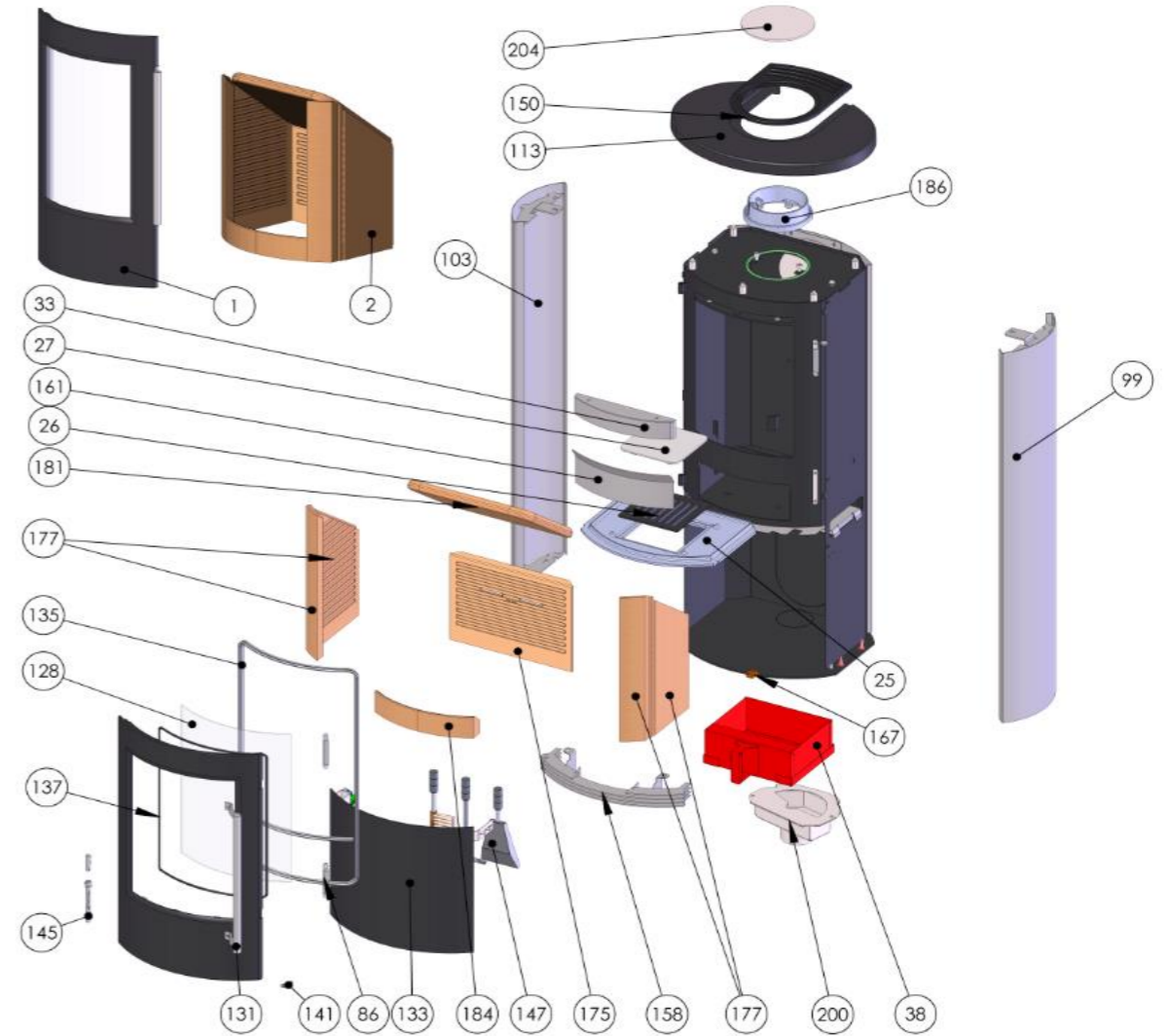

DK: "Dette dokument og indholdet i samme, tilhører TermaTech A/S. Det må ikke kopieres, sælges, distribueres eller på anden måde gengives uden skriftlig tilladelse fra TermaTech A/S."

GB: "This document and its content, is the property of TermaTech A/S, and may not be copied, sold or distributed in any form, without prior written consent by TermaTech A/S"

DE: "Sämtliche Inhalte dieser Dokumente sind unser Eigentum und gehören ausschließlich TermaTech A/S. Es darf nicht ohne die schriftliche Genehmigung von TermaTech A/S kopiert, verkauft, verteilt oder anderweitig reproduziert werden."

FR: "Ce document et son contenu appartient intégralement à TermaTech A/S Il est formellement interdit de le copier, vendre, distribuer ou reproduire sans l'autorisation écrite de TermaTech A/S."

Position no.:	Colour:	Item number:	Position no.:	Colour:	Item number:	Position no.:	Colour:	Item number:
1	black	09-868	158		9999			
2		09-840	161		09-164			
25		09-820	167		09-836			
26		09-313	175		09-841			
27		09-824	177		09-842			
33	black	09-166	181		09-844			
38		09-834	184		09-843			
86		09-710	186	black	09-904			
99	black	9999	200	black	09-162			
103	black	9999	204	black	09-728			
113	black	09-866						
128		09-815						
131		09-870						
133		9999						
135		09-625						
137		09-634						
141		9999						
145		09-832						
147		09-524						
150	black	09-872						

TermaTech AS Gunnar Clausens Vej 36 DK-8260 Viby J Tlf.: +45 87 42 00 35 Fax: +45 87 42 00 36 info@termatech.com www.termatech.com



# Type: TT21RHS

Item No.: S01-638 black  
 Drawing: 40914

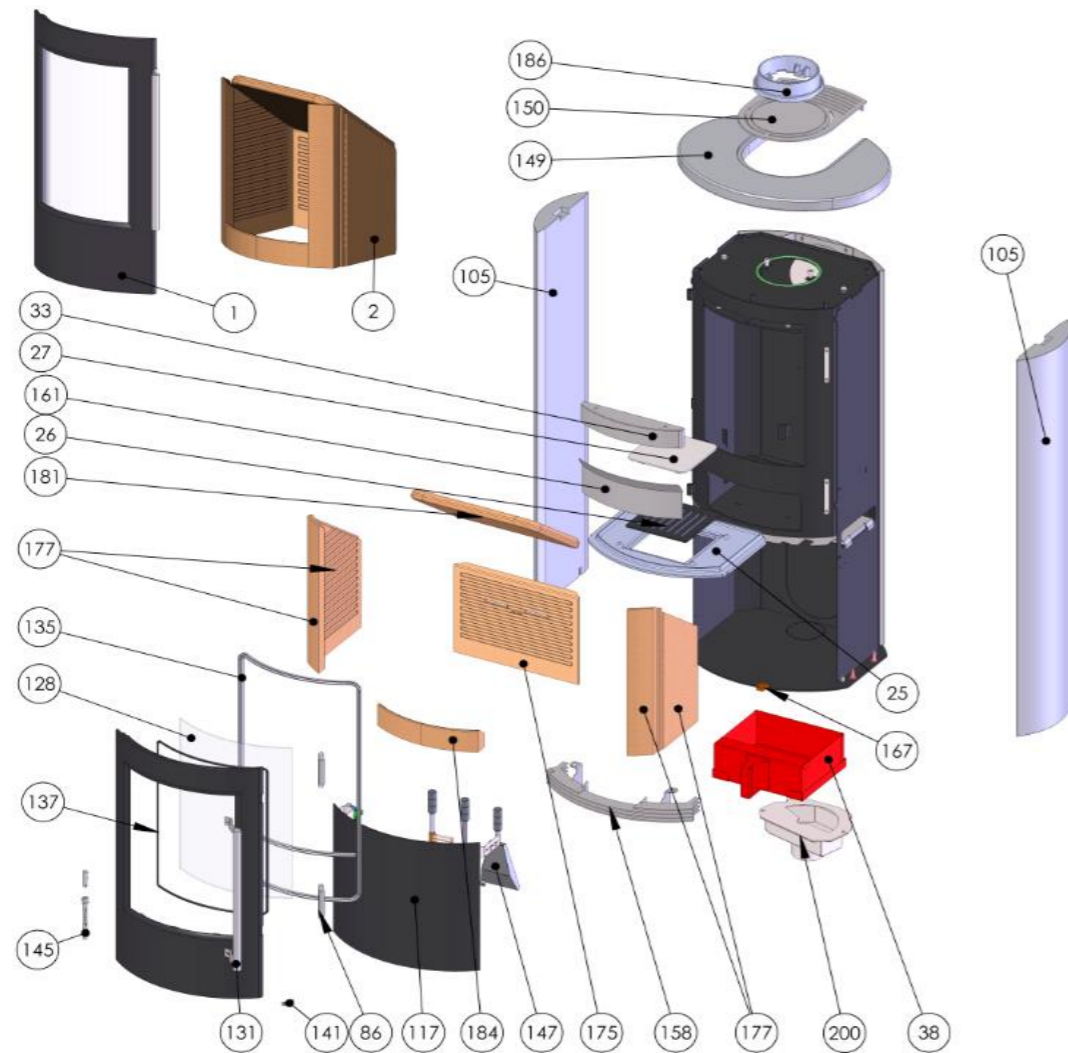

DK: "Dette dokument og indholdet i samme, tilhører TermaTech A/S. Det må ikke kopieres, sælges, distribueres eller på anden måde gengives uden skriftlig tilladelse fra TermaTech A/S."

GB: "This document and its content, is the property of TermaTech A/S, and may not be copied, sold or distributed in any form, without prior written consent by TermaTech A/S"

DE: "Sämtliche Inhalte dieser Dokumente sind unser Eigentum und gehören ausschließlich TermaTech A/S. Es darf nicht ohne die schriftliche Genehmigung von TermaTech A / S kopiert, verkauft, verteilt oder anderweitig reproduziert werden."

FR: "Ce document et son contenu appartient intégralement à TermaTech A/S Il est formellement interdit de le copier, vendre, distribuer ou reproduire sans l'autorisation écrite de TermaTech A/S. »

Position no.:	Colour:	Item number:	Position no.:	Colour:	Item number:	Position no.:	Colour:	Item number:
1		09-868	158		9999			
2		09-840	161		09-164			
25		09-820	167		09-836			
26		09-313	175		09-841			
27		09-824	177		09-842			
33		09-166	181		09-844			
38		09-834	184		09-843			
86		09-710	186		09-904			
105		08-462	200		09-162			
117		9999						
128		09-815						
131		09-870						
135		09-625						
137		09-634						
141		9999						
145		09-832						
147		09-524						
149		08-405						
150		08-406						

TermaTech AS Gunnar Clausens Vej 36 DK-8260 Viby J Tlf.: +45 87 42 00 35 Fax: +45 87 42 00 36 info@termatech.com www.termatech.com

# Type TT22

Item No.: S01-640 black  
 Item No.: S01-641 dark grey  
 Drawing: 41901

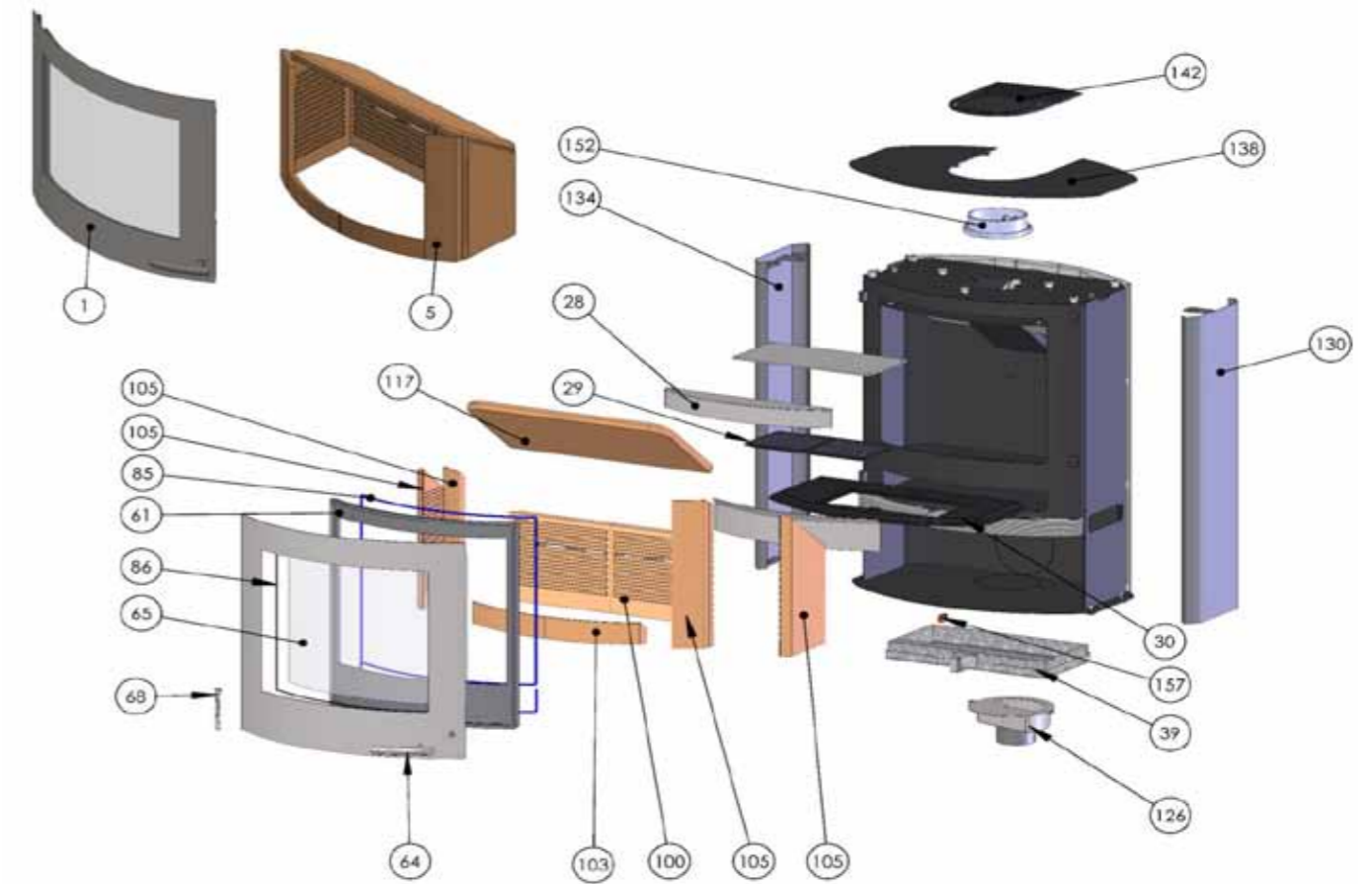

DK: "Dette dokument og indholdet i samme, tilhører TermaTech A/S. Det må ikke kopieres, sælges, distribueres eller på anden måde gengives uden skriftlig tilladelse fra TermaTech A/S."

GB: "This document and its content, is the property of TermaTech A/S, and may not be copied, sold or distributed in any form, without prior written consent by TermaTech A/S"

DE: "Sämtliche Inhalte dieser Dokumente sind unser Eigentum und gehören ausschließlich TermaTech A/S. Es darf nicht ohne die schriftliche Genehmigung von TermaTech A / S kopiert, verkauft, verteilt oder anderweitig reproduziert werden."

Position no.:	Colour:	Item number:	Position no.:	Colour:	Item number:	Position no.:	Colour:	Item number:
1	black	09-562	117		09-574	157		09-836
	dark grey	09-563	126	black	09-552			
5		09-570	130	black	09-566			
28		9999		dark grey	09-567			
29		09-313	134	black	09-568			
30		09-565		dark grey	09-569			
39		09-550	138	black	09-558			
61		09-564		dark grey	09-559			
64		09-830	142	black	09-576			
65		09-554		dark grey	09-577			
68		09-832						
85		09-624						
86		09-634						
100		09-571						
103		09-572	152	black	09-904			
105		09-573		dark grey	09-905			

TermaTech AS Gunnar Clausens Vej 36 DK-8260 Viby J Tlf.: +45 87 42 00 35 Fax: +45 87 42 00 36 info@termatech.com www.termatech.com

# Type TT22S

Item No.: S01-642 black  
 Item No.: S01-643 dark grey  
 Drawing.: 41902

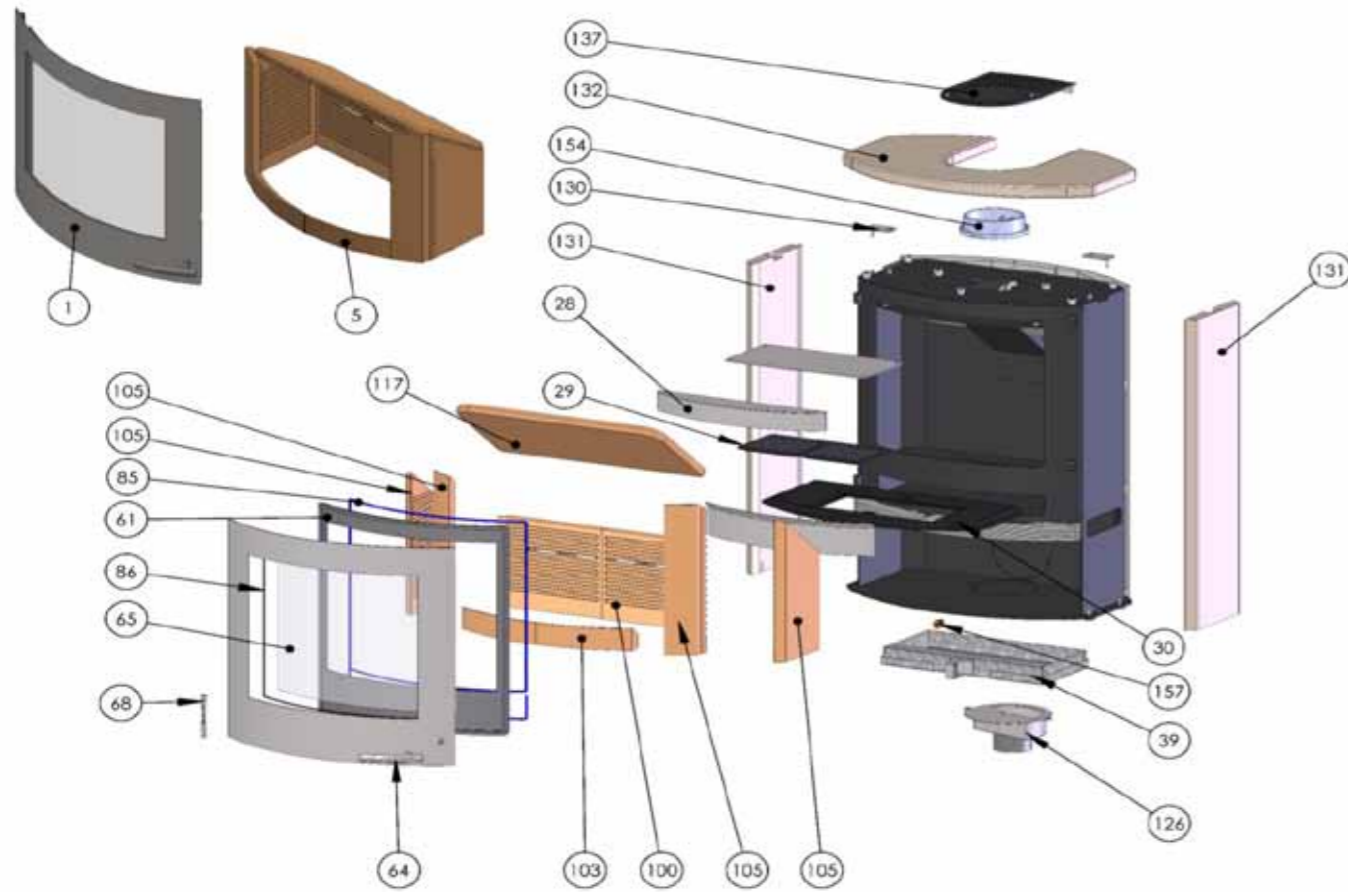

DK: "Dette dokument og indholdet i samme, tilhører TermaTech A/S. Det må ikke kopieres, sælges, distribueres eller på anden måde gengives uden skriftlig tilladelse fra TermaTech A/S."  
 GB: "This document and its content, is the property of TermaTech A/S, and may not be copied, sold or distributed in any form, without prior written consent by TermaTech A/S"  
 DE: "Sämtliche Inhalte dieser Dokumente sind unser Eigentum und gehören ausschließlich TermaTech A/S. Es darf nicht ohne die schriftliche Genehmigung von TermaTech A/S kopiert, verkauft, verteilt oder anderweitig reproduziert werden."

Position no.:	Colour:	Item number:	Position no.:	Colour:	Item number:	Position no.:	Colour:	Item number:
1	black	09-562	105		09-573			
	dark grey	09-563	117		09-574			
5		09-570	126	black	09-552			
28		9999	130		08-433			
29		09-313	131		08-430			
30		09-565	132		08-432			
39		09-550						
61		09-564	137	black	09-560			
64		09-830		dark grey	09-561			
65		09-554						
68		09-832	154	black	09-904			
85		09-624		dark grey	09-905			
86		09-634						
100		09-571	157		09-836			
103		09-572						

# Type TT22R

Item No.: S01-648 black  
 Drawing.: 41906

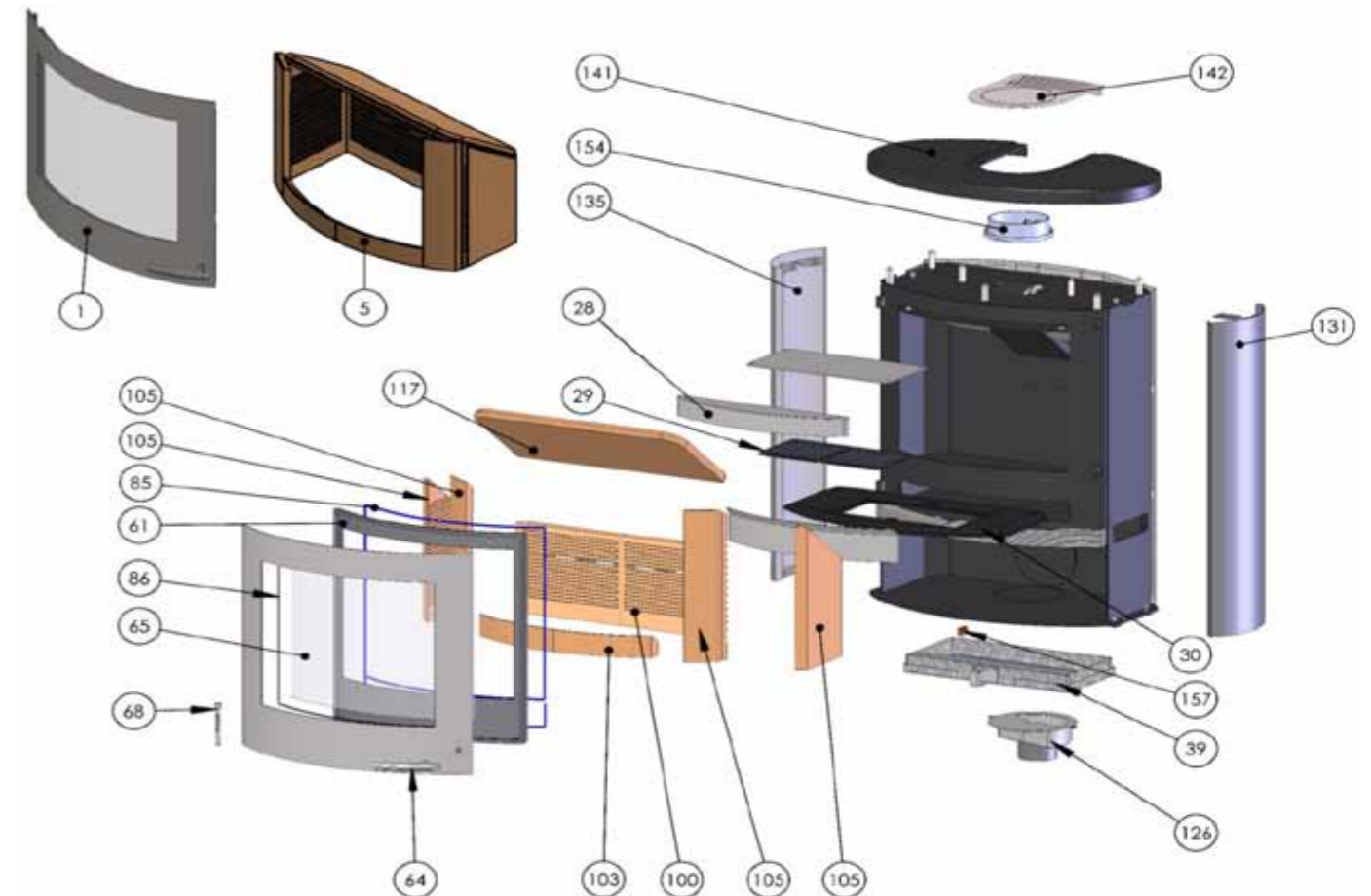

DK: "Dette dokument og indholdet i samme, tilhører TermaTech A/S. Det må ikke kopieres, sælges, distribueres eller på anden måde gengives uden skriftlig tilladelse fra TermaTech A/S."  
 GB: "This document and its content, is the property of TermaTech A/S, and may not be copied, sold or distributed in any form, without prior written consent by TermaTech A/S"  
 DE: "Sämtliche Inhalte dieser Dokumente sind unser Eigentum und gehören ausschließlich TermaTech A/S. Es darf nicht ohne die schriftliche Genehmigung von TermaTech A/S kopiert, verkauft, verteilt oder anderweitig reproduziert werden."

Position no.:	Colour:	Item number:	Position no.:	Colour:	Item number:	Position no.:	Colour:	Item number:
1	black	09-562	100		09-571			
5		09-570	103		09-572			
28		9999	105		09-573			
29		09-313	117		09-574			
30		09-565	126	black	09-552			
39		09-550	131	black	09-596			
61		09-564	135	black	09-598			
64		09-830	141	black	09-590			
65		09-554	142	black	09-592			
68		09-832	154	black	09-904			
85		09-624	157		09-836			
86		09-634						



# Type TT22RP

Item No.: S01-654 black  
 Drawing.: 41907

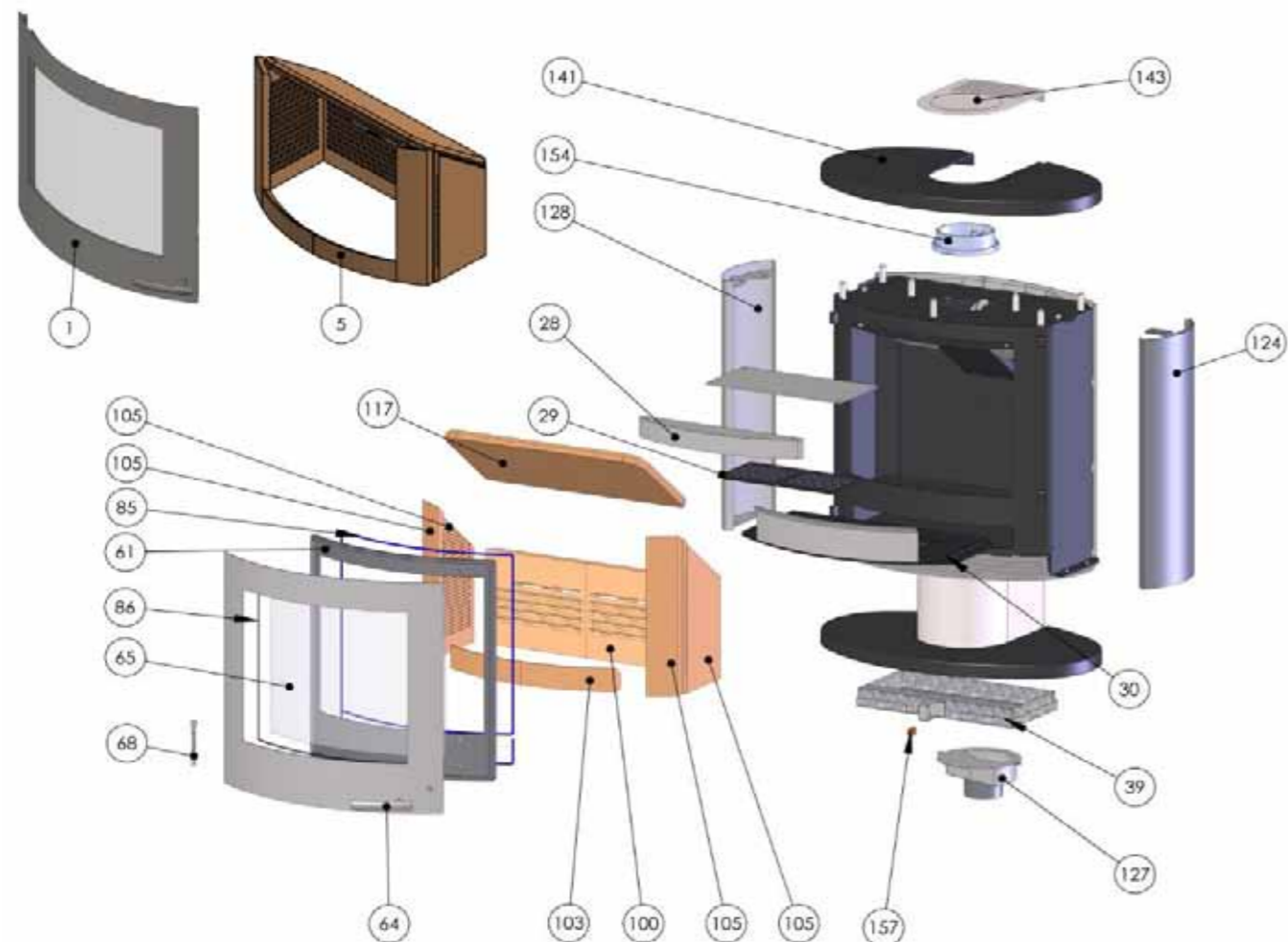

# Type TT22H

Item No.: S01-644 black  
 Item No.: S01-645 dark grey  
 Drawing.: 41903

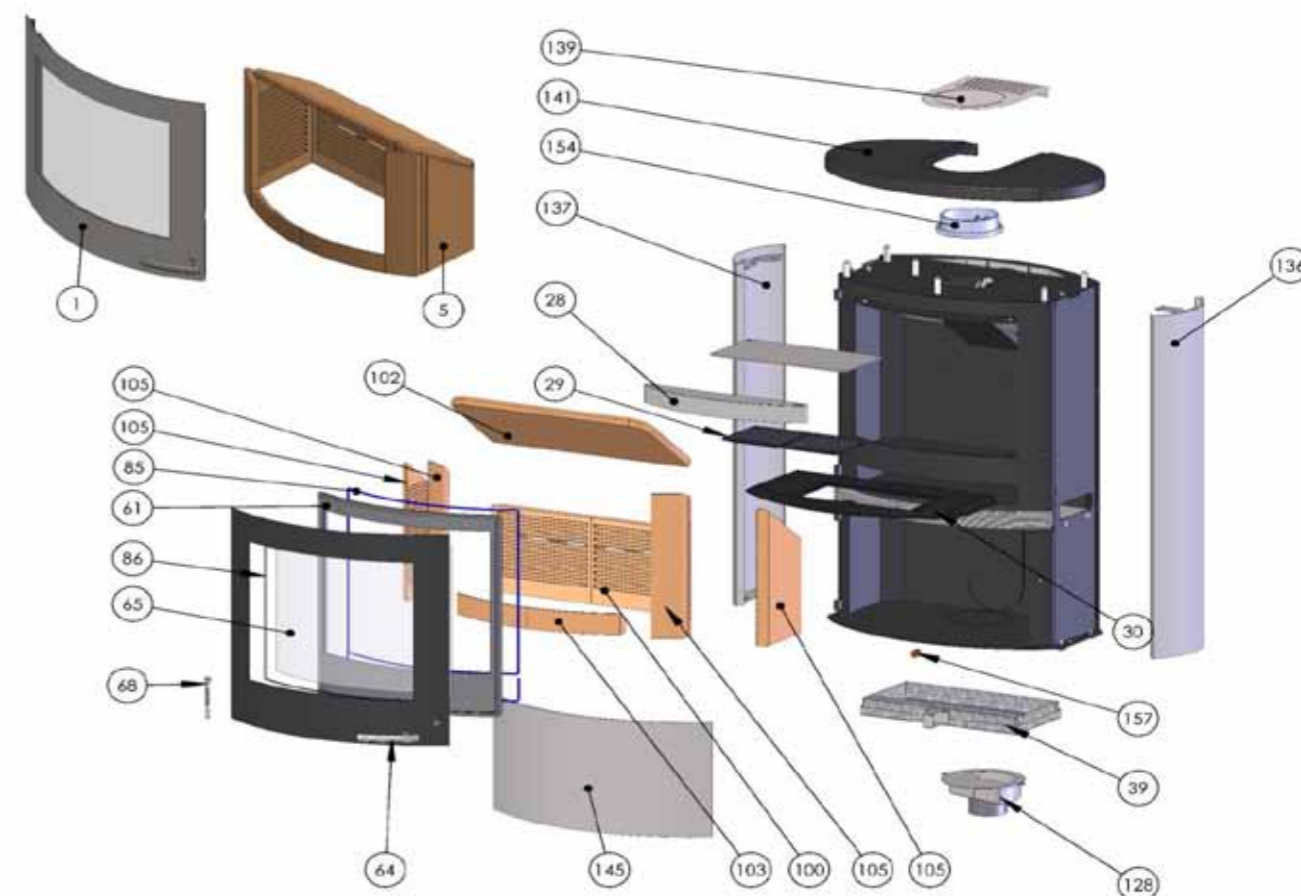

DK: "Dette dokument og indholdet i samme, tilhører TermaTech A/S. Det må ikke kopieres, sælges, distribueres eller på anden måde gengives uden skriftlig tilladelse fra TermaTech A/S."  
 GB: "This document and its content, is the property of TermaTech A/S, and may not be copied, sold or distributed in any form, without prior written consent by TermaTech A/S"  
 DE: "Sämtliche Inhalte dieser Dokumente sind unser Eigentum und gehören ausschließlich TermaTech A/S. Es darf nicht ohne die schriftliche Genehmigung von TermaTech A/S kopiert, verkauft, verteilt oder anderweitig reproduziert werden."  
 FR: "Ce document et son contenu appartient intégralement à TermaTech A/S. Il est formellement interdit de le copier, vendre, distribuer ou reproduire sans l'autorisation écrite de TermaTech A/S."

DK: "Dette dokument og indholdet i samme, tilhører TermaTech A/S. Det må ikke kopieres, sælges, distribueres eller på anden måde gengives uden skriftlig tilladelse fra TermaTech A/S."  
 GB: "This document and its content, is the property of TermaTech A/S, and may not be copied, sold or distributed in any form, without prior written consent by TermaTech A/S"  
 DE: "Sämtliche Inhalte dieser Dokumente sind unser Eigentum und gehören ausschließlich TermaTech A/S. Es darf nicht ohne die schriftliche Genehmigung von TermaTech A/S kopiert, verkauft, verteilt oder anderweitig reproduziert werden."

Position no.:	Colour:	Item number:	Position no.:	Colour:	Item number:	Position no.:	Colour:	Item number:
1	black	09-562	100		09-571			
5		09-570	103		09-572			
28		9999	105		09-573			
29		09-313	117		09-574			
30		09-565	124	black	09-580			
39		09-550	127	black	09-552			
61		09-564	128	black	09-582			
64		09-830	141	black	09-590			
65		09-554	143	black	09-592			
68		09-832	154	black	09-904			
85		09-624	157		09-836			
86		09-634						

Position no.:	Colour:	Item number:	Position no.:	Colour:	Item number:	Position no.:	Colour:	Item number:
1	black	09-562	102		09-574	145	black	09-594
	dark grey	09-563	103		09-572		dark grey	09-595
			105		09-573			
5		09-570	128	black	09-552	154	black	09-904
28		9999					dark grey	09-905
29		09-313	136	black	09-854			
30		09-565		dark grey	09-855	157		09-836
39		09-550						
61		09-564	137	black	09-856			
64		09-830		dark grey	09-857			
65		09-554	139	black	09-592			
68		09-832		dark grey	09-593			
85		09-624						
86		09-634						
100		09-571	141	black	09-590			
				dark grey	09-591			

# Type TT22HS

Item No.: S01-646 black  
 Item No.: S01-647 dark grey  
 Drawing.: 41904

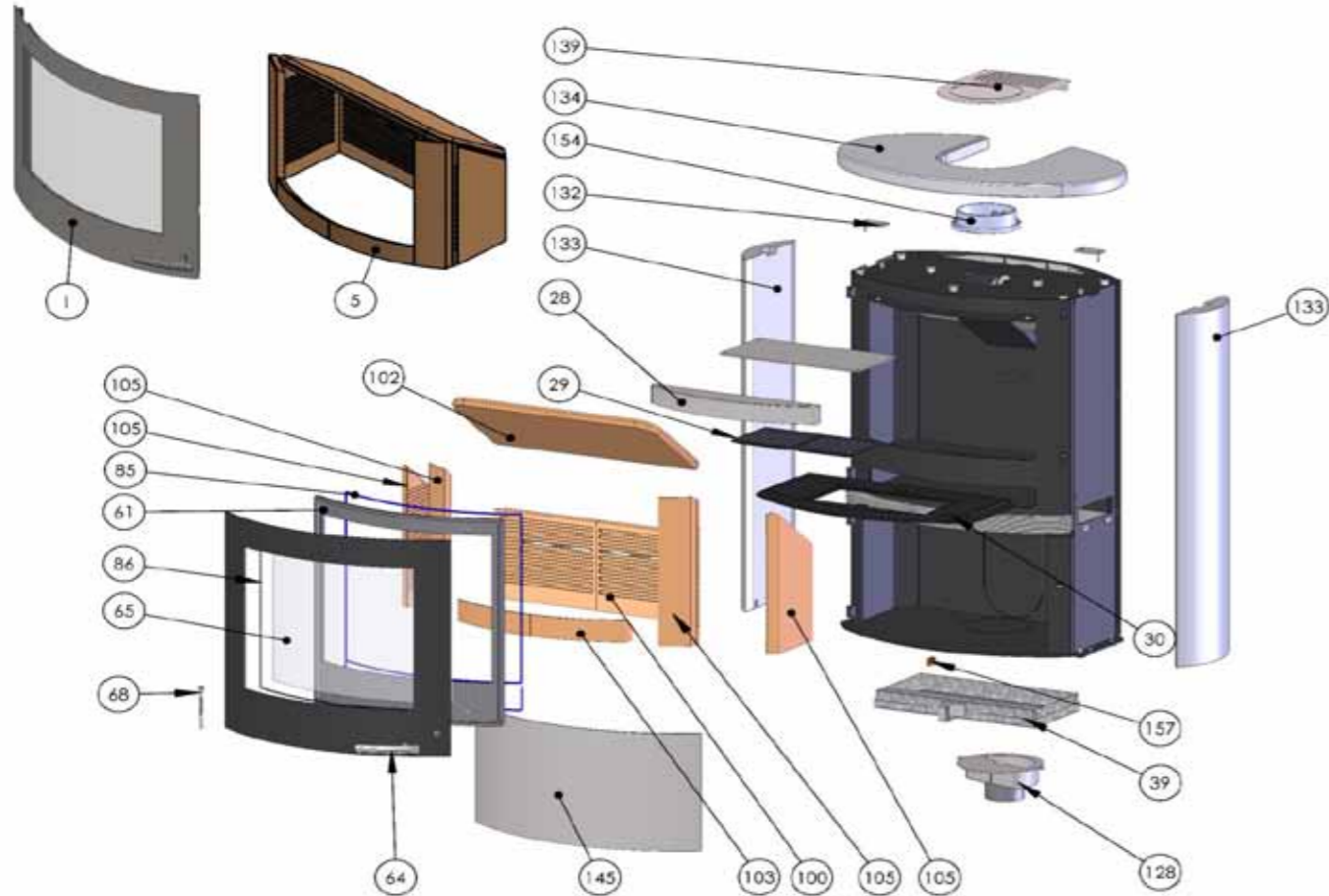

DK: "Dette dokument og indholdet i samme, tilhører TermaTech A/S. Det må ikke kopieres, sælges, distribueres eller på anden måde gengives uden skriftlig tilladelse fra TermaTech A/S."  
 GB: "This document and its content, is the property of TermaTech A/S, and may not be copied, sold or distributed in any form, without prior written consent by TermaTech A/S"  
 DE: "Sämtliche Inhalte dieser Dokumente sind unser Eigentum und gehören ausschließlich TermaTech A/S. Es darf nicht ohne die schriftliche Genehmigung von TermaTech A/S kopiert, verkauft, verteilt oder anderweitig reproduziert werden."

Position no.:	Colour:	Item number:	Position no.:	Colour:	Item number:	Position no.:	Colour:	Item number:
1	black	09-562	100		09-571	154	black	09-904
	dark grey	09-563	102		09-574		dark grey	09-905
			103		09-572			
5		09-570	105		09-573	157		09-836
28		9999	128	black	09-552			
29		09-313	132		08-433			
30		09-565	133		08-412			
39		09-550	134		08-440			
61		09-564						
64		09-830	139	black	09-560			
65		09-554		dark grey	09-561			
68		09-832						
85		09-624	145	black	09-594			
86		09-634		dark grey	09-595			

# Type TT22HST

Item No.: S01-650 black  
 Item No.: S01-651 dark grey  
 Drawing.: 41905

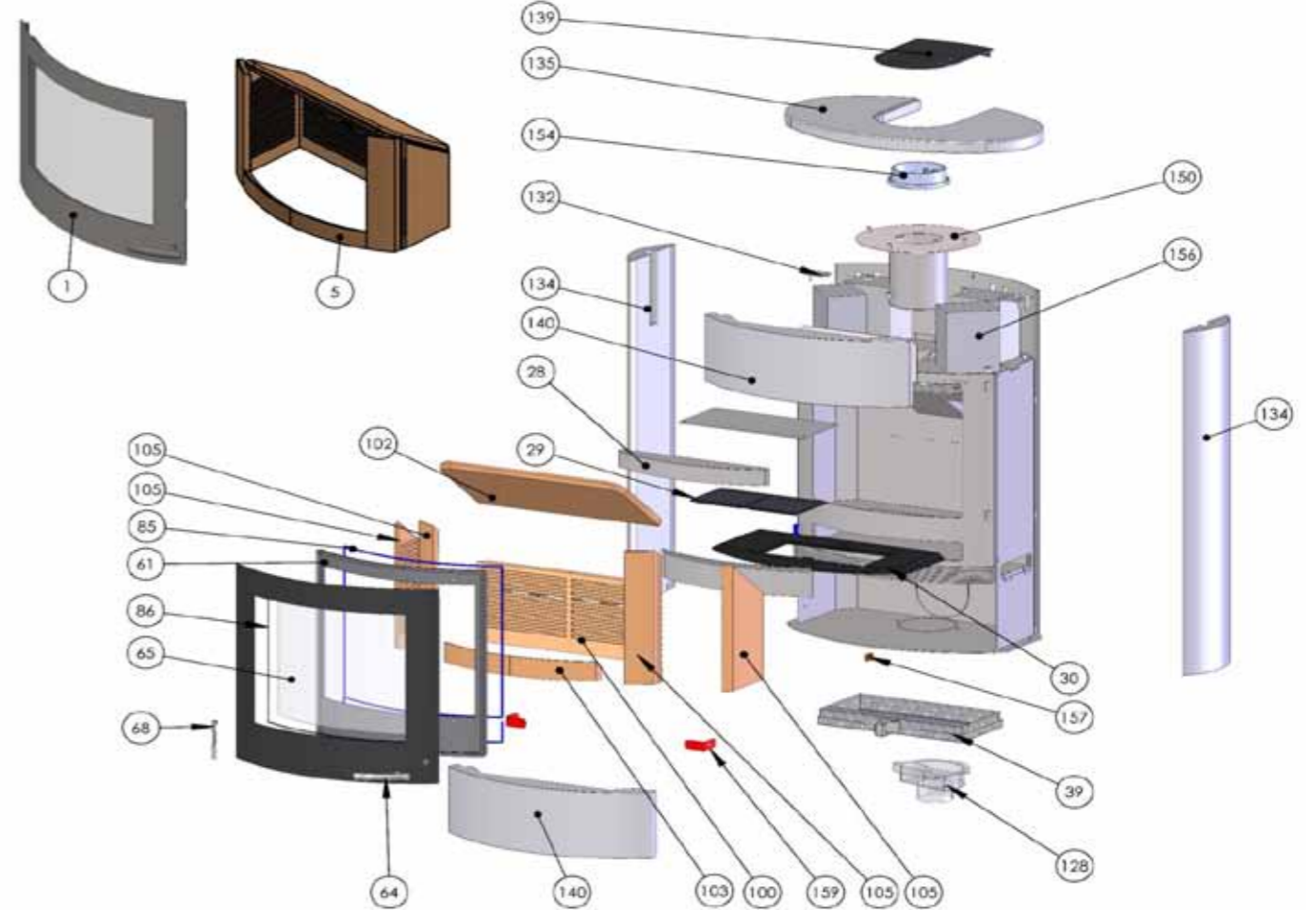

DK: "Dette dokument og indholdet i samme, tilhører TermaTech A/S. Det må ikke kopieres, sælges, distribueres eller på anden måde gengives uden skriftlig tilladelse fra TermaTech A/S."  
 GB: "This document and its content, is the property of TermaTech A/S, and may not be copied, sold or distributed in any form, without prior written consent by TermaTech A/S"  
 DE: "Sämtliche Inhalte dieser Dokumente sind unser Eigentum und gehören ausschließlich TermaTech A/S. Es darf nicht ohne die schriftliche Genehmigung von TermaTech A/S kopiert, verkauft, verteilt oder anderweitig reproduziert werden."

Position no.:	Colour:	Item number:	Position no.:	Colour:	Item number:	Position no.:	Colour:	Item number:
1	black	09-562	100		09-571	154	black	09-904
	dark grey	09-563	102		09-574		dark grey	09-905
			103		09-572			
5		09-570	105		09-573	156		08-453
28		9999	128	black	09-552	157		09-836
29		09-313	132		08-433	159		9999
30		09-565	134		08-451			
39		09-550	135		08-440			
61		09-564						
64		09-830	139	black	09-560			
65		09-554		dark grey	09-561			
68		09-832						
85		09-624	140		08-452			
86		09-634	150		9999			

# Type TT30

Item No.: S01-700 black  
 Item No.: S01-701 dark grey  
 Drawing.: 30901

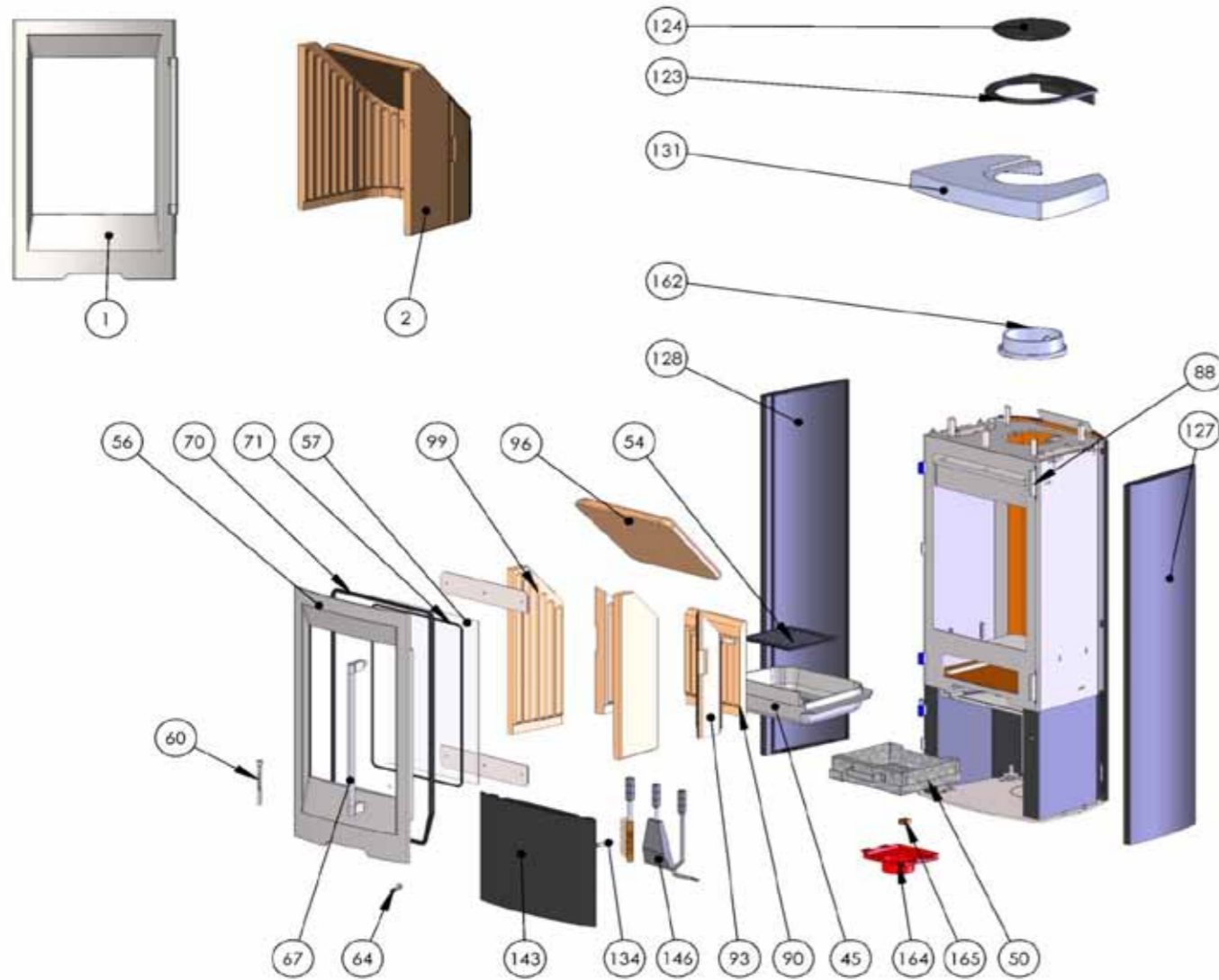

DK: "Dette dokument og indholdet i samme, tilhører TermaTech A/S. Det må ikke kopieres, sælges, distribueres eller på anden måde gengives uden skriftlig tilladelse fra TermaTech A/S."  
 GB: "This document and its content, is the property of TermaTech A/S, and may not be copied, sold or distributed in any form, without prior written consent by TermaTech A/S"  
 DE: "Sämtliche Inhalte dieser Dokumente sind unser Eigentum und gehören ausschließlich TermaTech A/S. Es darf nicht ohne die schriftliche Genehmigung von TermaTech A / S kopiert, verkauft, verteilt oder anderweitig reproduziert werden."

Position no.:	Colour:	Item number:	Position no.:	Colour:	Item number:	Position no.:	Colour:	Item number:
1	black	09-730	88	black	09-710	131	black	09-724
	dark grey	09-731		dark grey	09-711		dark grey	09-725
2		09-713	90		09-716	134		09-712
45	black	09-722	93		09-717	143	black	09-732
50		09-740	96		09-715		dark grey	09-733
54		09-313	99		09-718	146	black	09-524
56	black	9999	123	black	09-726	162	black	09-904
	dark grey	9999		dark grey	09-727		dark grey	09-905
57		09-700	124	black	09-728	164		9999
60		09-832		dark grey	09-729	165		09-836
64		9999	127	black	09-742			
67		09-702		dark grey	09-743			
70		09-623	128	black	09-744			
71		09-634		dark grey	09-745			

# Type TT30S

Item No.: S01-720 black  
 Item No.: S01-721 dark grey  
 Drawing.: 30903

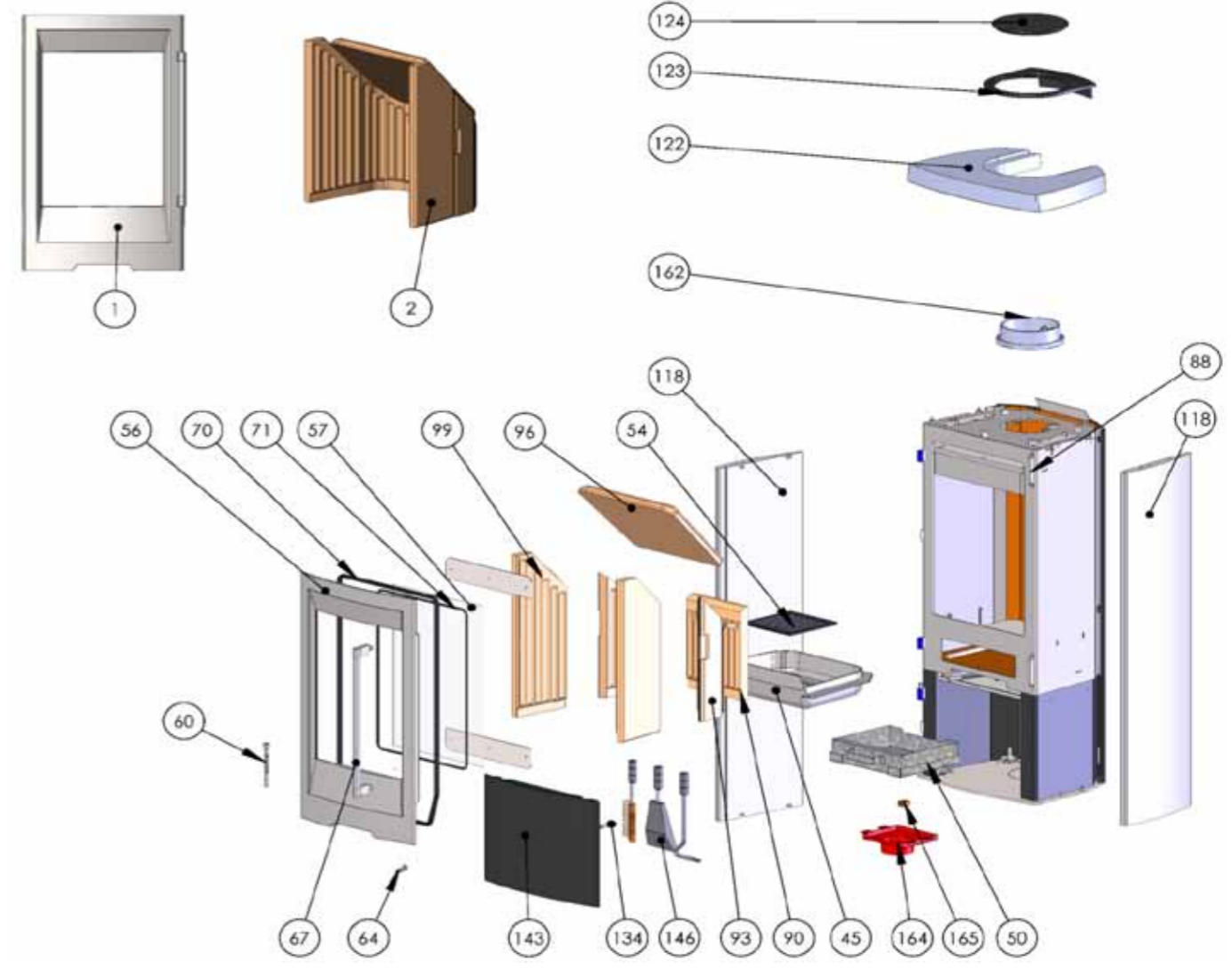

DK: "Dette dokument og indholdet i samme, tilhører TermaTech A/S. Det må ikke kopieres, sælges, distribueres eller på anden måde gengives uden skriftlig tilladelse fra TermaTech A/S."  
 GB: "This document and its content, is the property of TermaTech A/S, and may not be copied, sold or distributed in any form, without prior written consent by TermaTech A/S"  
 DE: "Sämtliche Inhalte dieser Dokumente sind unser Eigentum und gehören ausschließlich TermaTech A/S. Es darf nicht ohne die schriftliche Genehmigung von TermaTech A / S kopiert, verkauft, verteilt oder anderweitig reproduziert werden."

Position no.:	Colour:	Item number:	Position no.:	Colour:	Item number:	Position no.:	Colour:	Item number:
1	black	09-730	90		09-716	162	black	09-904
	dark grey	09-731	93		09-717		dark grey	09-905
2		09-713	96		09-715	164		9999
45	black	09-722	99		09-718	165		09-836
50		09-740	118		08-501			
54		09-313	122		08-500			
56	black	9999	123	black	09-726			
	dark grey	9999		dark grey	09-727			
57		09-700	124	black	09-728			
60		09-832		dark grey	09-729			
64		9999	134		09-712			
67		09-702	143	black	09-732			
70		09-623		dark grey	09-733			
71		09-634	146	black	09-524			
88	black	09-710						
	dark grey	09-711						

# Type TT30G

Item No. 501-710 black  
 Item No. 501-711 dark grey  
 Drawing. 30902

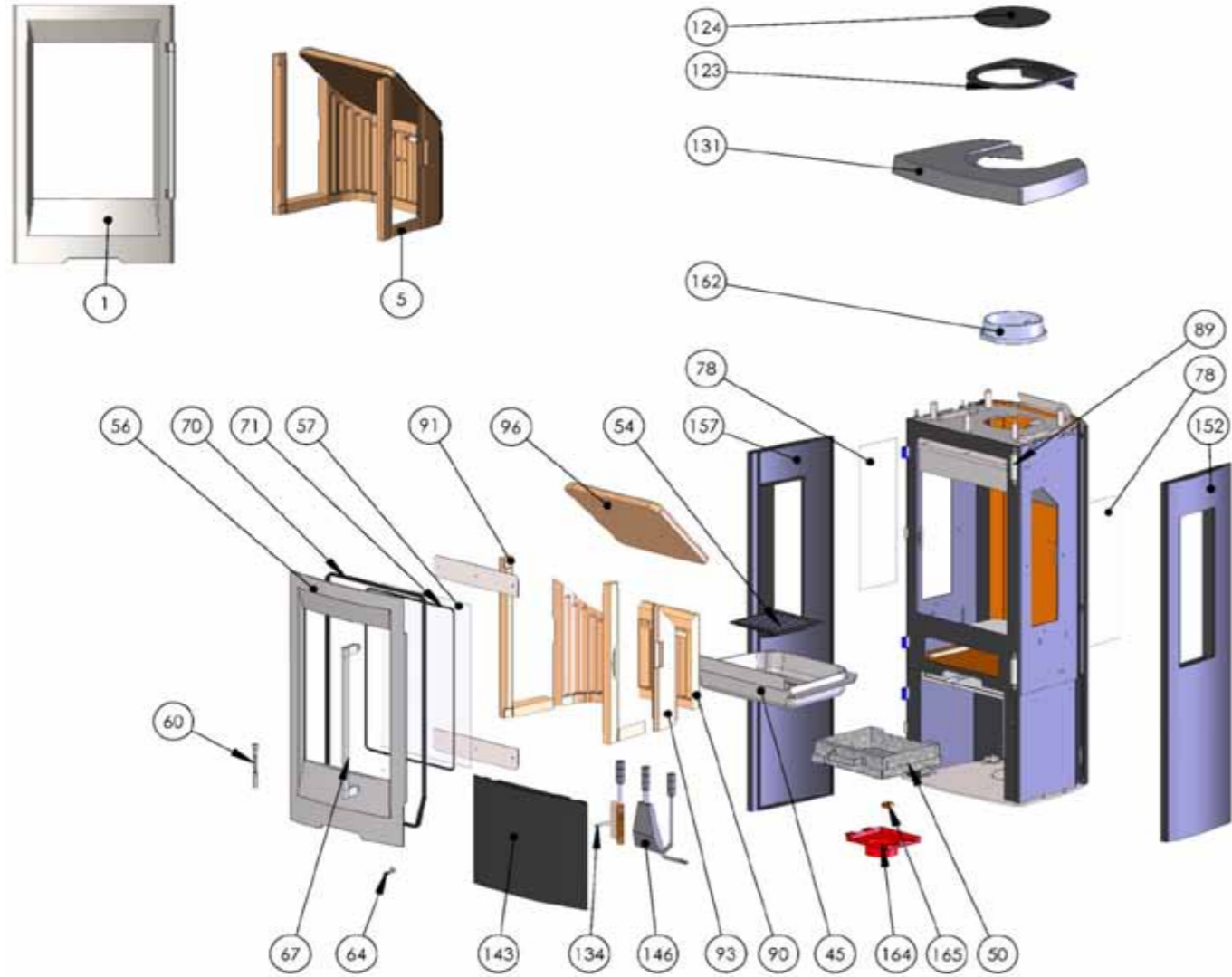

DK: "Dette dokument og indholdet i samme, tilhører TermaTech A/S. Det må ikke kopieres, sælges, distribueres eller på anden måde gengives uden skriftlig tilladelse fra TermaTech A/S."  
 GB: "This document and its content, is the property of TermaTech A/S, and may not be copied, sold or distributed in any form, without prior written consent by TermaTech A/S"  
 DE: "Sämtliche Inhalte dieser Dokumente sind unser Eigentum und gehören ausschließlich TermaTech A/S. Es darf nicht ohne die schriftliche Genehmigung von TermaTech A/S kopiert, verkauft, verteilt oder anderweitig reproduziert werden."

Position no.:	Colour:	Item number:	Position no.:	Colour:	Item number:	Position no.:	Colour:	Item number:
1	black	09-730	89	black	09-710	143	black	09-732
	dark grey	09-731		dark grey	09-711		dark grey	09-733
5		09-714	90		09-716	146	black	09-524
45	black	09-722	91		09-719	152	black	09-746
50		09-740	93		09-717		dark grey	09-747
54		09-313	96		09-715	157	black	09-748
56	black	9999					dark grey	09-749
	dark grey	9999	123	black	09-726	162	black	09-904
57		09-700		dark grey	09-727		dark grey	09-905
60		09-832	124	black	09-728	164		9999
64		9999		dark grey	09-729	165		09-836
67		09-702	131	black	09-724			
70		09-623		dark grey	09-725			
71		09-634	134		09-712			
78		09-701						

# Type TT30GS

Item No. 501-712 black  
 Item No. 501-713 dark grey  
 Drawing. 30904

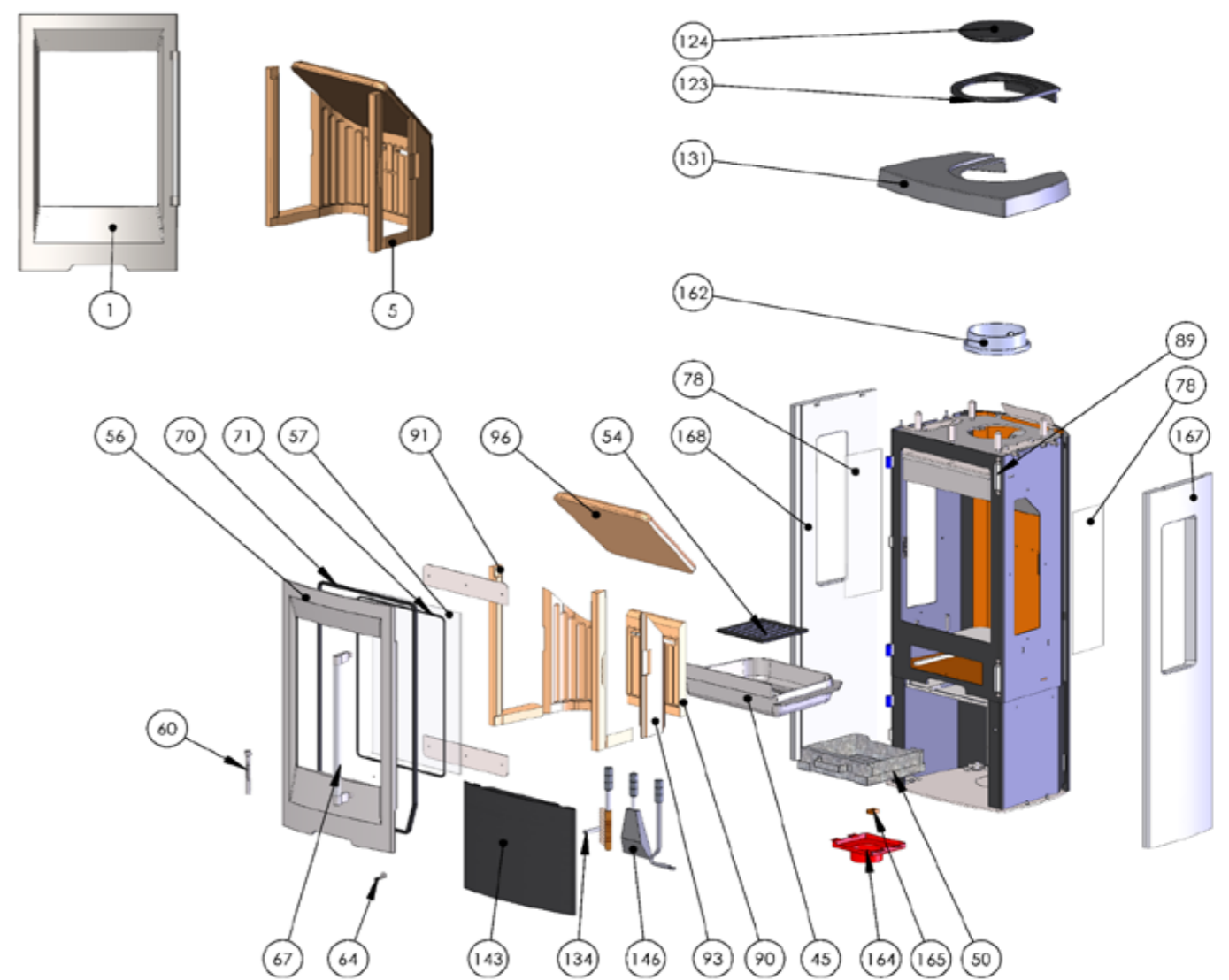

DK: "Dette dokument og indholdet i samme, tilhører TermaTech A/S. Det må ikke kopieres, sælges, distribueres eller på anden måde gengives uden skriftlig tilladelse fra TermaTech A/S."  
 GB: "This document and its content, is the property of TermaTech A/S, and may not be copied, sold or distributed in any form, without prior written consent by TermaTech A/S"  
 DE: "Sämtliche Inhalte dieser Dokumente sind unser Eigentum und gehören ausschließlich TermaTech A/S. Es darf nicht ohne die schriftliche Genehmigung von TermaTech A/S kopiert, verkauft, verteilt oder anderweitig reproduziert werden."

Position no.:	Colour:	Item number:	Position no.:	Colour:	Item number:	Position no.:	Colour:	Item number:
1	black	09-730	89	black	09-710	143	black	09-732
	dark grey	09-731		dark grey	09-711		dark grey	09-733
5		09-714	90		09-716	146	black	09-524
45	black	09-722	91		09-719	162	black	09-904
50		09-740	93		09-717		dark grey	09-905
54		09-313	96		09-715	164		9999
56	black	9999				165		09-836
	dark grey	9999	123	black	09-726	167		08-503
57		09-700		dark grey	09-727	168		08-504
60		09-832	124	black	09-728			
64		9999		dark grey	09-729			
67		09-702	131		08-500			
70		09-623	134		09-712			
71		09-634						
78		09-701						

# Type TT60

Item No. 501-670 black  
Drawing. 60901

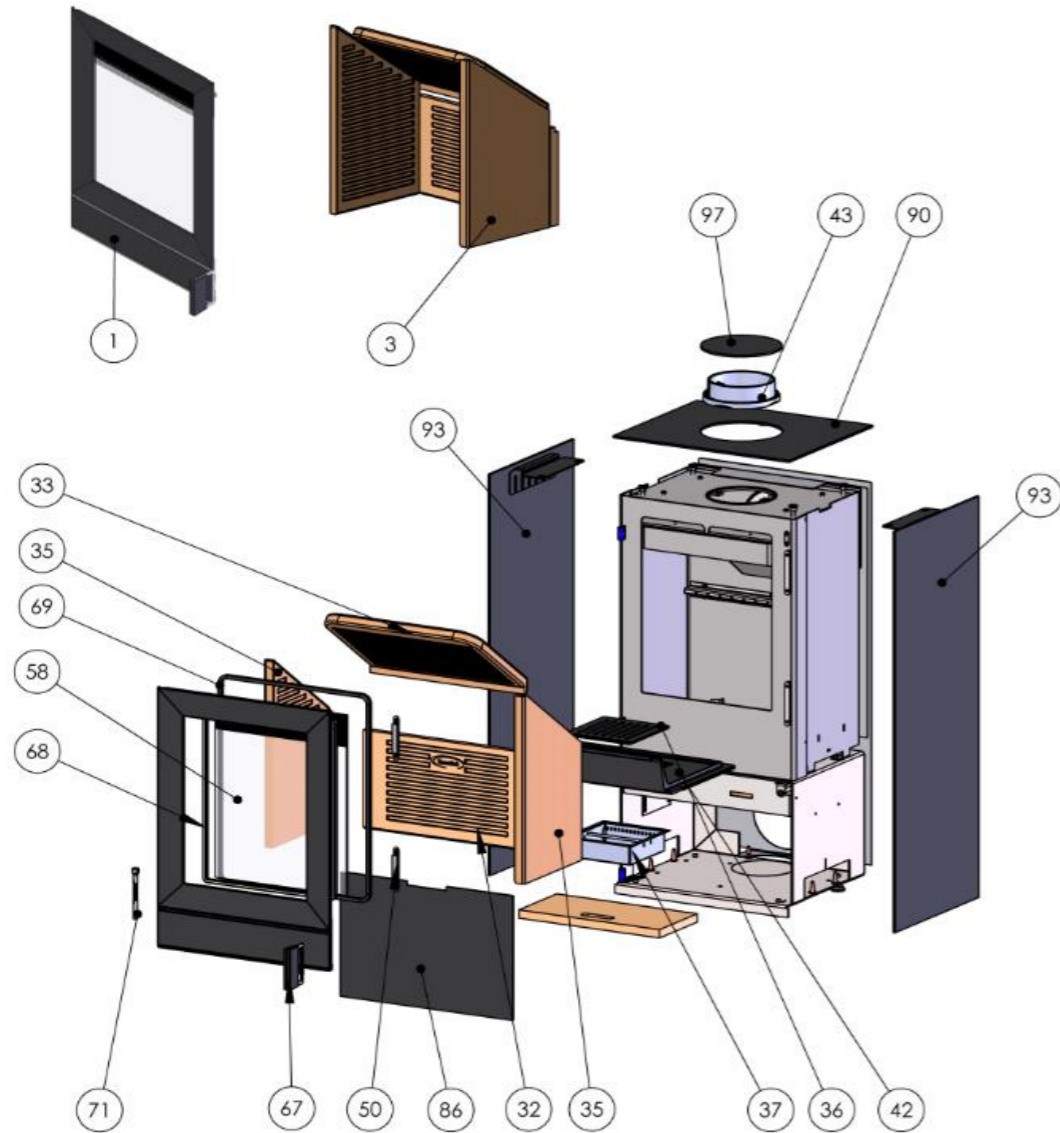

DK: "Dette dokument og indholdet i samme, tilhører TermaTech A/S. Det må ikke kopieres, sælges, distribueres eller på anden måde gengives uden skriftlig tilladelse fra TermaTech A/S."  
GB: "This document and its content, is the property of TermaTech A/S, and may not be copied, sold or distributed in any form, without prior written consent by TermaTech A/S"  
DE: "Sämtliche Inhalte dieser Dokumente sind unser Eigentum und gehören ausschließlich TermaTech A/S. Es darf nicht ohne die schriftliche Genehmigung von TermaTech A/S kopiert, verkauft, verteilt oder anderweitig reproduziert werden."  
FR: "Ce document et son contenu appartient intégralement à TermaTech A/S Il est formellement interdit de le copier, vendre, distribuer ou reproduire sans l'autorisation écrite de TermaTech A/S. »

Position no.:	Colour:	Item number:	Position no.:	Colour:	Item number:	Position no.:	Colour:	Item number:
1	black	09-676	86	black	09-688			
3		09-670	90	black	09-682			
32		09-672	93	black	09-678			
33		09-671	97	black	9999			
35		09-673						
36		09-313						
37		09-650						
42		09-674						
43	black	09-904						
50		09-708						
58		09-600						
67		09-602						
68		09-634						
69		09-636						
71		09-832						

TermaTech AS Gunnar Clausens Vej 36 DK-8260 Viby J Tlf.: +45 87 42 00 35 Fax: +45 87 42 00 36 info@termatech.com www.termatech.com

# Type TT60S

Item No. 501-672 black  
Drawing. 60902

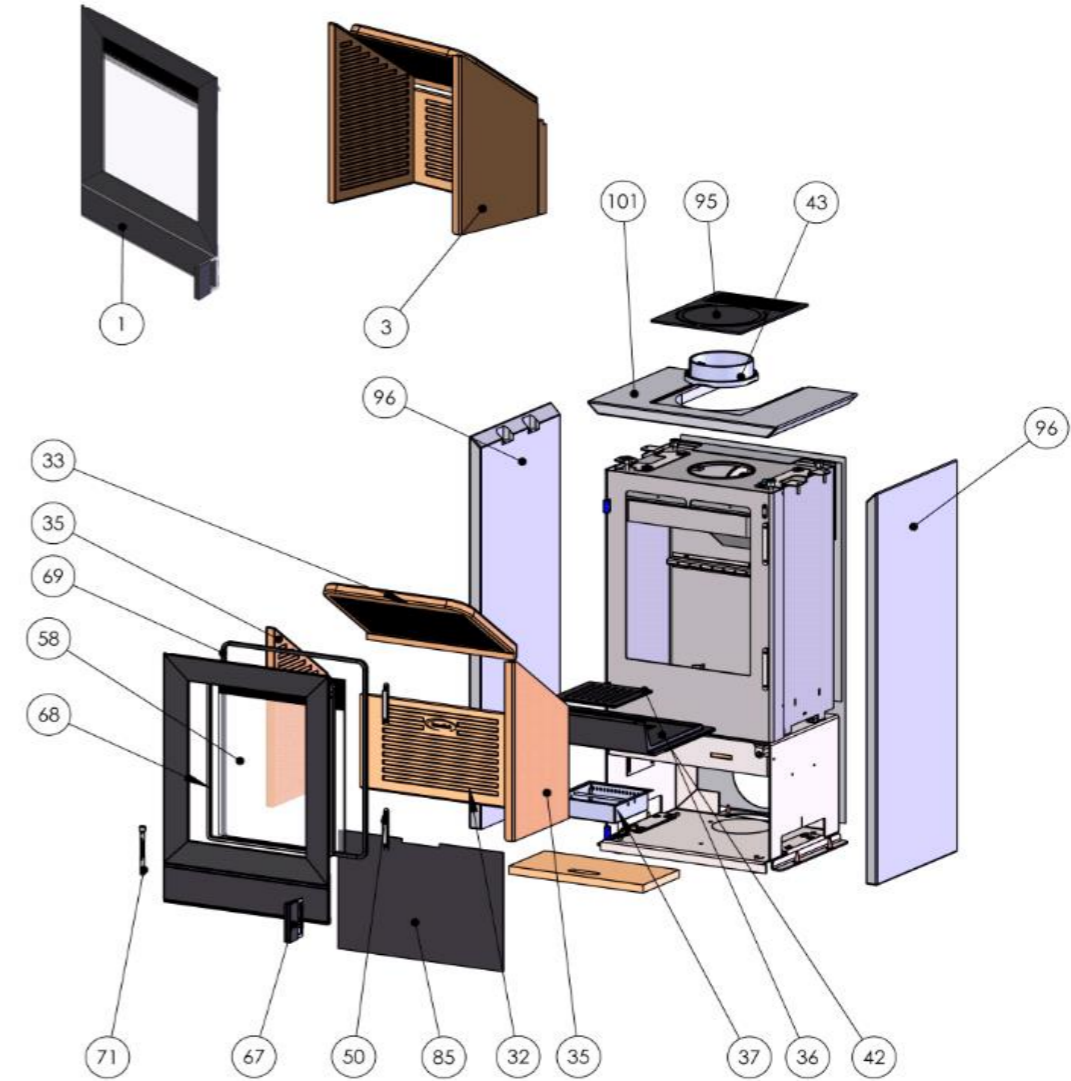

DK: "Dette dokument og indholdet i samme, tilhører TermaTech A/S. Det må ikke kopieres, sælges, distribueres eller på anden måde gengives uden skriftlig tilladelse fra TermaTech A/S."  
GB: "This document and its content, is the property of TermaTech A/S, and may not be copied, sold or distributed in any form, without prior written consent by TermaTech A/S"  
DE: "Sämtliche Inhalte dieser Dokumente sind unser Eigentum und gehören ausschließlich TermaTech A/S. Es darf nicht ohne die schriftliche Genehmigung von TermaTech A/S kopiert, verkauft, verteilt oder anderweitig reproduziert werden."  
FR: "Ce document et son contenu appartient intégralement à TermaTech A/S Il est formellement interdit de le copier, vendre, distribuer ou reproduire sans l'autorisation écrite de TermaTech A/S. »

Position no.:	Colour:	Item number:	Position no.:	Colour:	Item number:	Position no.:	Colour:	Item number:
1	black	09-676	85	black	09-688			
3		09-670	95	black	09-684			
32		09-672	96		08-602			
33		09-671	101		08-600			
35		09-673						
36		09-313						
37		09-650						
42		09-674						
43	black	09-904						
50		09-708						
58		09-600						
67	black	09-602						
68		09-634						
69		09-636						
71		09-832						

TermaTech AS Gunnar Clausens Vej 36 DK-8260 Viby J Tlf.: +45 87 42 00 35 Fax: +45 87 42 00 36 info@termatech.com www.termatech.com

# Type TT60W

Item No. S01-674 black  
Drawing. 60903

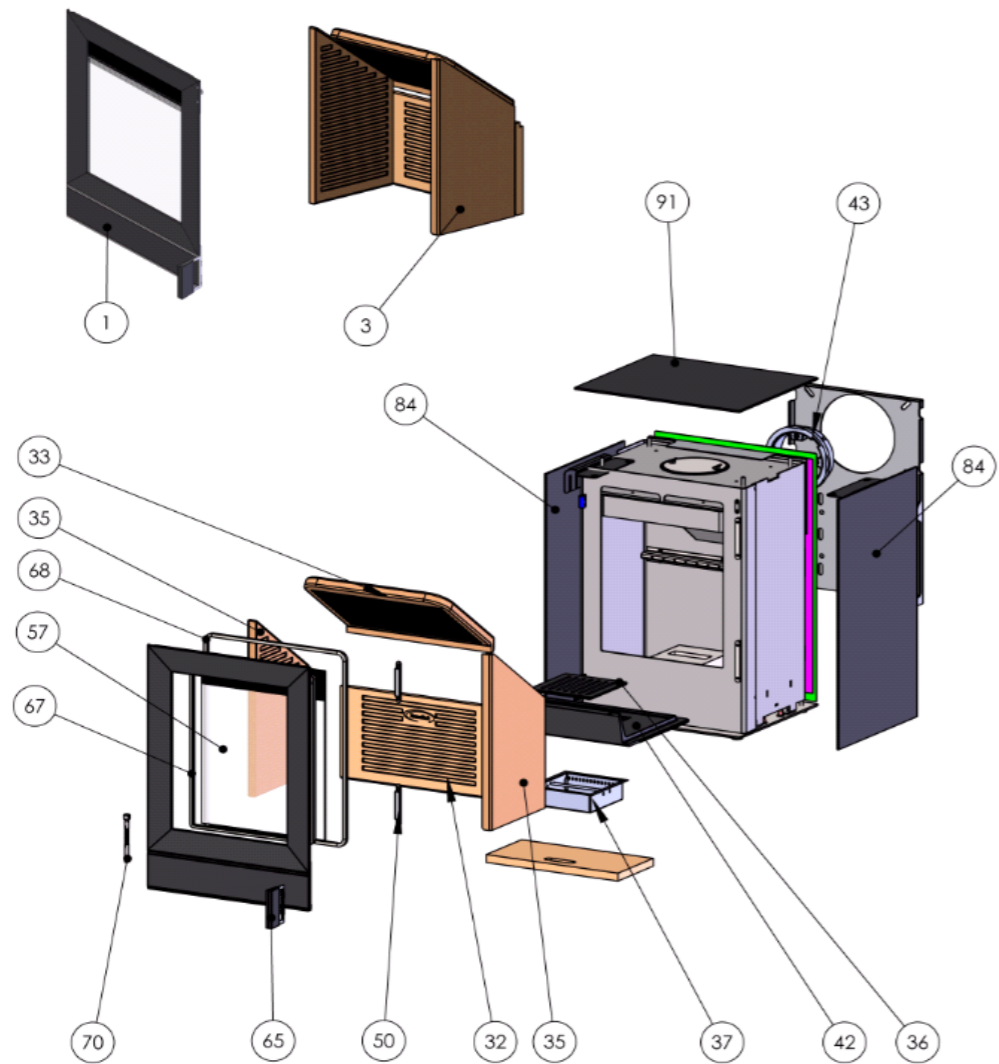

DK: "Dette dokument og indholdet i samme, tilhører TermaTech A/S. Det må ikke kopieres, sælges, distribueres eller på anden måde gengives uden skriftlig tilladelse fra TermaTech A/S."  
 GB: "This document and its content, is the property of TermaTech A/S, and may not be copied, sold or distributed in any form, without prior written consent by TermaTech A/S"  
 DE: "Sämtliche Inhalte dieser Dokumente sind unser Eigentum und gehören ausschließlich TermaTech A/S. Es darf nicht ohne die schriftliche Genehmigung von TermaTech A / S kopiert, verkauft, verteilt oder anderweitig reproduziert werden."  
 FR: "Ce document et son contenu appartient intégralement à TermaTech A/S Il est formellement interdit de le copier, vendre, distribuer ou reproduire sans l'autorisation écrite de TermaTech A/S. >

Position no.:	Colour:	Item number:	Position no.:	Colour:	Item number:	Position no.:	Colour:	Item number:
1	black	09-676	70		09-832			
3		09-670	84	black	9999			
32		09-672	91		9999			
33		09-671						
35		09-673						
36		09-313						
37		09-650						
42		09-674						
43	black	09-904						
50		09-708						
57		09-600						
65		09-602						
67		09-634						
68		09-636						





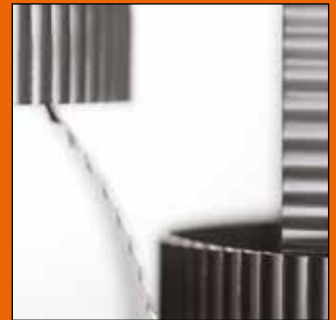

[www.termatech.com](http://www.termatech.com)